



SAFETY AT THE HIGHEST LEVEL

Easi - Dec Platform & Roofline System

Operating Instructions



Temporary access device conforming to the test requirements of
BS EN 12811 CLASS 2 & EN 13374 CLASS C

Easi-Dec Access Systems Ltd.,
Merlin House,
Blaydon Road,
Sandy
SG19 1RZ
Tel: +44 (0) 1767 691812
Fax: +44 (0) 1767 691802

E-Mail: info@easi-dec.com
Internet: www.easi-dec.co.uk

Copyright © 2012 Kee Safety Ltd. All rights reserved.

List of Contents

Chapter	Subject	Page
0	Introduction	0
0.1	Summary	0-1
0.2	General	0-2
0.3	Use in Accordance With Regulations and Incorrect Use	0-4
0.4	Operator's Duty of Care	0-6
0.5	Personnel Requirements	0-7
1	For Your Safety	1
1.1	Summary	1-1
1.2	Symbols	1-2
1.3	Basic Safety Instructions	1-4
2	Using the Easi-Dec Platform & Roofline System.	2
2.1	Summary	2-1
2.2	Transporting and Storing the Easi-Dec & Roofline System.	2-2
2.3	Checking the Component Parts	2-29
2.4	Selecting the Installation Site	2-30
2.5	Positioning the Easi-Dec & Roofline System.	2-48
2.6	Using the Easi-Dec & Roofline System.	2-50
2.7	Maintaining, Inspection and Disposal	2-54
2.8	Labels	2-57



List of Contents

Chapter	Subject	Page
	Annex	
	Inspection Book Sample Page	

Chapter 0

Introduction

Summary

This chapter is split into the following subjects:

Subject	Page
General	0-2
Use in Accordance With Regulations and Incorrect Use	0-4
Operator's Duty of Care	0-6
Personnel Requirements	0-7

General

Contents

General information about The Easi-Dec Platform & Roofline System

Manufacturer

Easi-Dec Access Systems Ltd.,
Merlin House,
Blaydon Road,
Sandy,
Bedfordshire,
SG19 1RZ

Tel.: +44 (0) 1767 691812
Fax: +44 (0) 1767 691802
E-Mail: info@easi-dec.com
Internet: www.easi-dec.co.uk

Applicability

These operating instructions apply to the following product:

Type: The Easi-Dec Platform & Roofline System

Health and Safety

Installers and users must comply with all relevant health and safety regulations. In the U.K., particular attention should be drawn to the H.S.E. publication:

INDG 284 – Working on roofs.

U.K. based installers/ users may obtain copies of the above publication – free of charge – from their Health and Safety Executive area office.

Familiarisation



WARNING! Before using the Easi-Dec Platform & Roofline System for the first time, it is strongly recommended that users familiarise themselves with the product, these instructions, the terms used to describe the various parts and the marking on the product. It is essential that users fully understand these **before** using Easi-Dec Platform & Roofline System at the worksite.

ANY COMPONENT INCLUDING GUARDRAIL MUST BE REPLACED IN THE EVENT OF A DYNAMIC EVENT

System Compliance

- Tested in accordance with BS EN 12811 CLASS 2 & EN13374 CLASS C.
 - Designed to comply with the Working at Height Regulations.
-

Anticipated Life

Metal Components	Up to 10 years in non-marine, non-corrosive (e.g. chemical plant) environments with a temperature range from -10 to + 40 degrees centigrade subject to use and inspection strictly in accordance with these instructions.
Dec Boards (Plywood)	12 Months in non-marine, non-corrosive conditions

Storage and Components

- These Operating instructions form a component part of The Easi-Dec Platform & Roofline System. They must accompany the system and be followed for use.
 - At no time must any pages be removed from these instructions. If the instructions are lost in their entirety or in part, the instructions or the missing parts must be replaced immediately. Please contact your supplier or the manufacturer
-

Copyright

This documentation contains information protected by copyright. It may not be photocopied, reproduced, translated or recorded on data media, either completely or as extracts, without prior permission.

We reserve all further rights.

Amendment Service

This document is not subject to any amendment service from the manufacturer. Amendments to this documentation can be carried out without prior notice.

Modifications to the Easi-Dec Platform & Roofline System

If you undertake modifications to the Easi-Dec Platform & Roofline System, you will negate all certification that comes with this product! As a result, the declaration of conformity that you have received with the Easi-Dec Platform & Roofline System will be deemed as null and void. In this case, you must have all component parts of the system re-assessed for conformity in accordance with the applicable product guidelines and National Legislation.

Use In Accordance With Regulations and Incorrect Use

Contents

The use in accordance with regulations and incorrect use are described below.

Definition "Authorised Person"

A person is deemed to be an authorised person if they have had full Easi-Dec Training on how to use the equipment safely and been authorised to work on or with the Easi-Dec Platform & Roofline System in accordance with these instructions.

Use in Accordance With Regulations

The Easi-Dec Platform & Roofline System has been specifically designed for the housing maintenance industry for rapid access to roofline level, whilst spanning building obstructions such as porches and windows. The Modular design of Easi-Dec and its accessories enable it to be used independently, or to form the basis of the Roofline System.

The Easi-Dec Platform & Roofline System is governed by various workplace regulations and Guidelines. Assembly personnel must be familiar with the statutory requirements arising from these. They must also be familiar with and adhere to the following specifications and technical regulations

- Tested in accordance with BS EN 12811 CLASS 2 & EN13374 CLASS C.
- Designed to comply with the Working at Height Regulations

- Do not exceed the maximum distributed load of 300Kg per platform.
- All component parts must be used for the assembly of the system and correctly assembled.
- The Easi-Dec Platform & Roofline system may only be used when the supporting base is free from snow and ice. Do not use if there is the risk of frost or in freezing conditions.
- Do not position The Easi-Dec Platform & Roofline System where there is a risk of accumulation of water.
- Use of The Easi-Dec Platform & Roofline System in high winds is not permitted.
- Do not use against 'Green' new Brickwork.
- When handling or installing the Easi-Dec Platform & Roofline System care is necessary when the wind speed is in the region of 17mph. (gusting to 26m.p.h or over) All installation of the Easi-Dec Platform & Roofline System should cease when the average (mean) wind speed reaches 23 mph (gusting to 35 mph or over)
- Ladders must be secured against slipping, by securing at the top of the platforms using the supplied Ladder ties.
- The correct angle of rest for a ladder is 75 degrees, or a base to height ratio of 1:4.

Introduction 0-4 of 7

- The ladder must be of sufficient length to extend a sufficient height above the step-off point when used for access.
- To comply with the BS EN 12811 & EN13374 then the Dec's needs to be tied into the structure, however a risk assessment should be undertaken in all instances to ascertain the correct procedure.

Remember: always tie the Dec's into the structure if used as EN13374 edge protection.

Repeat:

Only use the Easi-Dec Platform & Roofline System when all conditions are met! ***Your life depends on it!***

Incorrect Use

The following conditions are classified as incorrect use:

- The use of the Easi-Dec Platform & Roofline System when one of the conditions listed under "use in accordance with regulations" is not met.
- The use of a damaged, incomplete or incorrectly assembled Easi-Dec Platform & Roofline System.
- Use as an anchor for access by rope or for abseiling.
- Used by an untrained operative without prior instruction by a competent, trained person.
- Use a Ladder or stepladder to gain extra height from the platform.

Use of the Easi-Dec Platform & Roofline System in any of the above conditions is forbidden. If the system is used incorrectly, a fatal fall or severe injuries may occur.



Danger to Life! Use of the Easi-Dec & Roofline System in any of the above conditions is forbidden. If the system is used incorrectly, a fatal fall or severe injuries may occur.

This document deals only with the product concerned. All those who work at height should be trained and competent in working at height techniques.

Operator's Duty of Care

Contents

The duties and obligations of the operator and trained personnel when dealing with The Easi-Dec Platform & Roofline System are set out below.

Safety of the Easi-Dec Platform & Roofline System

The operator or trained personnel must ensure that The Easi-Dec Platform & Roofline System:

- is used only in accordance with Health and Safety regulations,
 - is made available for use only in a proper, functional state.
 - is used in accordance with the regulations set out herein.
 - is checked regularly,
 - is used only by qualified, trained and authorised personnel.
-

Protection of Personnel

All persons using the system must ensure that the necessary personal protective equipment:

- is checked regularly and the check recorded
 - **IMPORTANT!** Wear suitable protective footwear to avoid injury to the feet in case any of the component parts are dropped or fall on to them.
 - **IMPORTANT!** Wear a hardhat to avoid injury to the in case any of the component parts are dropped or fall on to them.
-

Instruction and Training

All users of the system must ensure that:

- Before using the system for the first time and at least once annually thereafter, all personnel shall be instructed in all relevant matters of health and safety at work (with particular emphasis on Working at Height) and environmental protection,
 - The operating instructions are always available in a legible state, are complete and are kept with the system at all times.
 - All users are familiar with the contents of these operating instructions.
-

Personnel Requirements

Contents

The requirements the manufacturer places on the users of the Easi-Dec Platform & Roofline System are as follows:

Duties of the User

The user must fulfil the following duties:

- Operate The Easi-Dec Platform & Roofline System strictly in accordance with these instructions and check that it is functioning correctly and safely.
 - Recognise any damage to the system, or, missing parts. Immediately withdraw the system from use and return the system to the manufacturer for repairs/replacement parts.
-

Requirements of the User

In order to be able to fulfil his or her duties, the user must meet the following requirements:

- They must have received training from Easi-dec Access Systems Ltd, viewed the instructional DVD and have read the assembly guides provided.
 - They must have adequate knowledge of the language to understand these operating instructions.
 - They must be free from any disability that may affect their ability to use this system or understand these instructions.
 - It is unlikely that any medical condition may directly affect (or be affected by) the use of this product in itself, but users must be aware that:
 - Working at height is a dangerous occupation. They should be trained to do so, and should comply with any medical requirements set by the training provider.
-

Definition "Trained Person"

Trained persons, are persons who, based on their specialist training and experience have adequate knowledge of the system to be checked and are sufficiently familiar with the relevant regulations, guidelines and generally recognised rules of the Easi-Dec Platform & Roofline System and accompanying regulations - e.g., Health and Safety Regulations and Accident Prevention Regulations that are in force in the country of use; and can assess the safe working conditions of the installation location.

A trained person shall be responsible for selecting all users of the Easi-Dec Platform & Roofline System.

Chapter 1

For Your Safety

1.1 Summary

- **Important Information!**
 - The following safety information is to be understood as being in addition to any existing Health and Safety Regulations and laws already in force.
 - Existing accident prevention regulations and laws must be observed in all cases.
-

Summary

This chapter is split into the following subjects:

Subject	Page
Symbols	1-2
Basic Safety Instructions	1-4

1.2 Symbols

Contents

An Explanation of the symbols used follows.



Danger!

This symbol indicates that there is a risk to the life and safety of people.

Where life is endangered, the wording "**Danger to Life**" shall be indicated separately.



Attention!

This symbol indicates that there is a threat of damage to goods or to the environment.



Advice!

This symbol identifies information that contributes to the better understanding of the Easi-Dec Platform & Roofline System.



1.3 Basic Safety Instructions

Contents

Basic safety instructions for the safe handling of the Easi-Dec Platform & Roofline System can be found here.



Danger!

It is imperative that you follow these safety instructions to avoid endangering your life and safety:

Possible Danger	Measures for Avoidance
<p>Danger to Life! Risk of the user falling as a result of incorrect use.</p> <p>Explanation: Falls resulting in death or severe injuries can result from the incorrect use of the Easi-Dec Platform & Roofline System.</p>	<ul style="list-style-type: none"> ● Use the Easi-Dec Platform & Roofline System only as described in the operating instructions. ● Overhead power Lines. ● Before use, check all components and connector parts for correct positioning. ● Check for any damaged parts.
<p>Danger to Life! Danger of the user falling as the result of an inappropriate installation site.</p> <p>Explanation: An inadequate supporting base or assembly on type of 'Green Wall' not approved for use with this product can lead to the Easi-Dec Platform & Roofline System either slipping or falling - particularly if the user falls.</p>	<ul style="list-style-type: none"> ● Pay attention to the detailed instructions concerning the installation site, assembly and use of the Easi-Dec Platform & Roofline System in Chapter 2 of these user instructions. ● The supporting base or wall must always have the specified characteristics and load-bearing capacity. ● A risk assessment of the workplace must be carried out before use in all cases.



Danger to Life!

Danger of the user falling as a result of defective or inadequate maintenance.

Explanation:

Defects or damage relevant to safety can adversely affect the functionality of the Easi-Dec Platform & Roofline System. In these circumstances the safe functioning of the system is not assured.

- Before use, check Easi-Dec Platform & Roofline System for damage.
- Damaged parts must be replaced before use in all cases. Only after this may the Easi-Dec Platform & Roofline System be used!
- In case of doubt change the equipment
- In case of a fall change the equipment

Chapter 2

Using the Easi-Dec Platform & Roofline System

Summary

This chapter is split into the following subjects:

Subject	Page
Transporting and Storing the Easi-Dec Platform & Roofline System	2-2
Checking the Component parts	2 3-29
Selecting the Installation Site	2 - 30
Positioning the Easi-Dec Platform & Roofline System	2 31-48
Using the Easi-Dec Platform & Roofline System	2 49-50
Maintenance, Inspection and Disposal	2 51-54
Labels	2 55-57

Transporting and Storing the Easi-Dec Platform & Roofline System

Contents

Instructions for the safe transportation of the Easi-Dec Platform & Roofline System.



Danger!

Pack, store and transport Easi-Dec Platform and Roofline System, so all sub-assemblies & platforms are free from potential damage.

Packing

Easi-Dec components are of robust construction. While care should be taken during transportation not to cause any damage to them, special packaging is not required. In the case of transport by sea, the packing must be impervious to seawater.

Transportation

There are no restrictions to the means of transport.

Storage

Longer-term storage must be under cover for protection against the weather. All component parts must be stored on a flat surface to minimise any potential risk of damage.

Checking the component parts

Contents

The following is a review of all parts needed for the correct assembly of the Easi-Dec Platform & Roofline System.



Danger!



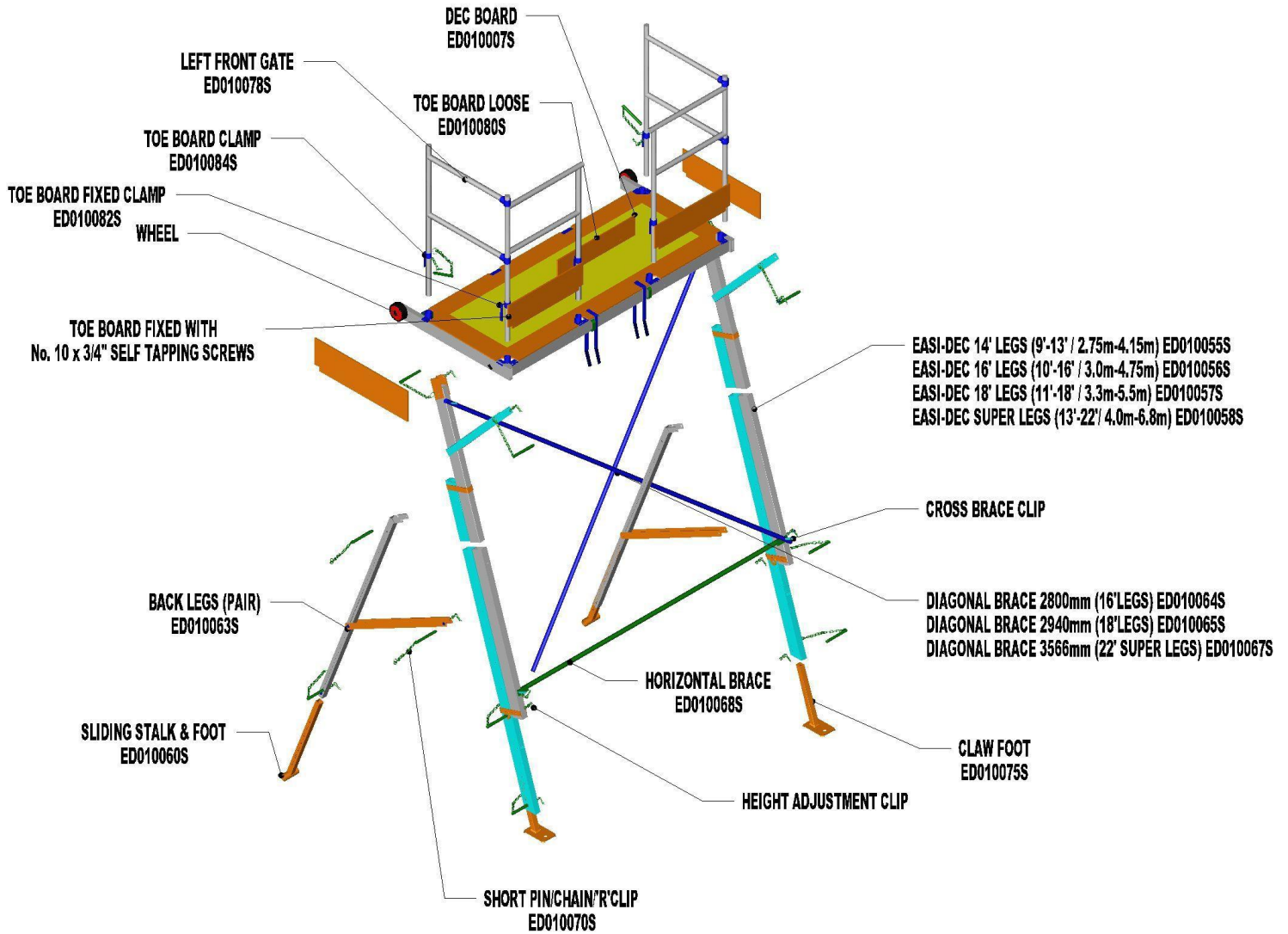

If all the parts shown in following diagrams are not present or if parts are damaged, they must be replaced by original parts. Contact your supplier or the manufacturer for advice.





EXPLODED DIAGRAM OF - (2m EASI-DEC COMPLETE - ED010001A)





Pictures for illustration only



The component parts depicted for the 2m Easi-Dec Platform have the following names and functions:

Item	Name	Function	Quantity
ED010001A	2m Dec Complete 	2m Easi-Dec Platform complete with <ul style="list-style-type: none"> • 1x Pair 18ft Legs • 1x Pair Back legs • 1x Pair Gates • 1x Set of Wheels • 1x Horizontal Brace Total Weight=75kg (approx.)	1 System
ED010007S	2m Dec Board 	Dec Board size 2000mm x 800mm (78" x 31") Buffalo Board. Total Weight of Dec Board = 2.2kg (approx.)	1 piece
ED010008S	2m Dec Gate set 	Guard Rail Total Weight =14kg (approx.)	1 pair Left & Right
ED010009S	Platform 2m Easi-Dec (No Gates or Legs) 	2000mm x 800mm platform. Total Weight =23kg (approx.)	1 piece
ED010010S	Platform 2m Easi-Dec with gates (No Legs) 	2000mm x 800mm Platform and Legs Total Weight =37kg (approx.)	

ED010040S	<p>Dec eye bolt c/w form nut & washers.</p> 	<p>Fixing the Easi-Dec Platform to the wall.</p> <p>Total Weight =0.16kg (approx.)</p>	1 piece
ED010042S	<p>Dec Support Struts 575mm – (Dec Set)</p> 	<p>Dec strut 575mm, connect using pin and “R”clip from outside in. (usually attached to the legs)</p> <p>Total Weight =3.2kg (approx.)</p>	2 per leg
ED010046S	<p>Gate draw bar</p> 	<p>Fitted into the Right Hand Gate to allow the closing off of the gate access point.</p> <p>Total Weight =0.6kg (approx.)</p>	1 piece
ED010053S	<p>Ladder Straps (Pair)</p> 	<p>Used to Tie Ladder to Dec</p>	1Pair
<p>ED030013A ED030014A ED030013S ED010055S ED010056S ED010057S ED010058S</p>	<p>4.7”Legs (3.3,-4.7”/1m-1.4m) (MICRO) 6.7”Legs (4.6,-6.7”/1.38m-2m) (MINI) 9.5”Legs (7.8,-9.6”/2.34m-2.9m) (b’low) 14”Legs (9,-13”/2.75m-4.15m) 16”Legs (10,-16”/3.0m-4.75m) 18”Legs (11,-18”/3.3m-5.5m) SLegs22 (13,-22”/4.0m-6.8m)</p> 	<p>Variable telescopic Legs enable access to first floor roofline Level or Super Legs for second floor roofline level.</p> <p>Red and Green stickers on platform and Legs indicate left and right handed legs.</p> <p>All pins to be inserted from the outside to minimise „R” clips being knocked out.</p>	1 Pair

ED010068S	<p>Horizontal Brace</p> 	<p>Used to stabilize legs in lateral direction.</p> <p>Connection made by placing the brace over studs and fitting „R“ clip.</p> <p>Total Weight of Brace=1kg (approx.) Note: ‘R” Clips point downward to avoid accidental dislodging.</p>	1 piece
ED010070S ED010069S	<p>75mm Short pin/chain/“R” clip set. 100mm Long pin/chain/“R” clip set.</p> 	<p>All pins to be inserted from the outside to minimise „R” clips from being accidently pushed out.</p>	

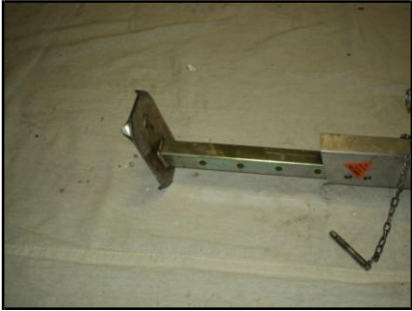
ED010088S	14" Legs (9 - 13" /2.75m-4.15m)	Single Leg Total Weight =10.7kg (approx.)	1 piece
ED010089S	16" Legs (10,-16" /3.0m-4.75m)	Single Leg Total Weight =12.2kg (approx.)	1 piece
ED010090S	18" Legs (11,-18" /3.3m-5.5m)	Single Leg Total Weight =13kg (approx.)	1 piece
ED010091S	SLegs22 (13,-22" /4.0m-6.8m)	Single Super Leg Total Weight =19.5kg (approx.)	1 piece
ED010094S	Back Leg	Single Back Leg. Total Weight =5.5kg (approx.)	1 piece

ED010071S	<p>Budgie step</p> 	<p>Temporary connection to the Super Leg to act as a step to replace pins and 'R' Clips.</p> <p>Total Weight =0.5kg (approx.)</p>	1 piece
ED010075S	<p>Claw Foot</p> 	<p>Used to aid stability of Dec with 150mm of adjustment in both feet for unlevelled ground.</p> <p>Use a spike of 400mm minimum Length through the hole in each of the feet.</p> <p>Total weight of foot = 2.2Kg (approx.)</p> <p>Note: This method of fixing applies only to turf and soft soil ground conditions.</p>	2 pieces
ED010078S	<p>Left front gate with integral Toe-board.</p> 	<p>Used as guardrail to prevent fall from height.</p> <p>Fit the Guardrails into the sockets and fix with PIN and „Clips”.</p> <p>Total weight of Left front gate = 7kg (approx.)</p> <p>NOTE : the guardrails should always be fitted with the platform at its lowest practical level.</p>	1 piece
ED010079S	<p>Right front gate with integral Toe-Boards (Inc Draw Bar).</p> 	<p>Used as guardrail to prevent fall from height. Fit the Guardrails into the sockets and fix with PIN and „Clips” .</p> <p>Total weight of Right front gate (Inc Draw Bar) = 7kg (approx.)</p> <p>NOTE : the guardrails should always be fitted with the platform at its lowest practical level.</p>	1 piece

ED010080S	<p>Toe-board (flip up)</p> 	<ul style="list-style-type: none"> Help Prevent debris falling off platform Dec. Raise the toe-board across the Ladder access point and clamp into position with Toe-board clips. Total weight of flip up Toe board = 0.5 kg (approx.) 	1 piece
ED010082S	<p>Toe-Board clamp fixed.</p> 	<p>Used to screw fix Toe-Board to clamp on the Gates. Total weight =0.6kg (approx.)</p>	2 piece
ED010084S	<p>Toe-Board clamp single</p> 	<p>Clamp over connection of Loose Toe-Board. Total Weight =2.2kg (approx.)</p>	2 piece
ED010086S	<p>Top Fix Kit (Includes Drill, Eyebolt & Plastic plugs)</p> 	<p>To secure Dec to the wall. Total weight =0.5kg (approx.)</p>	1 piece



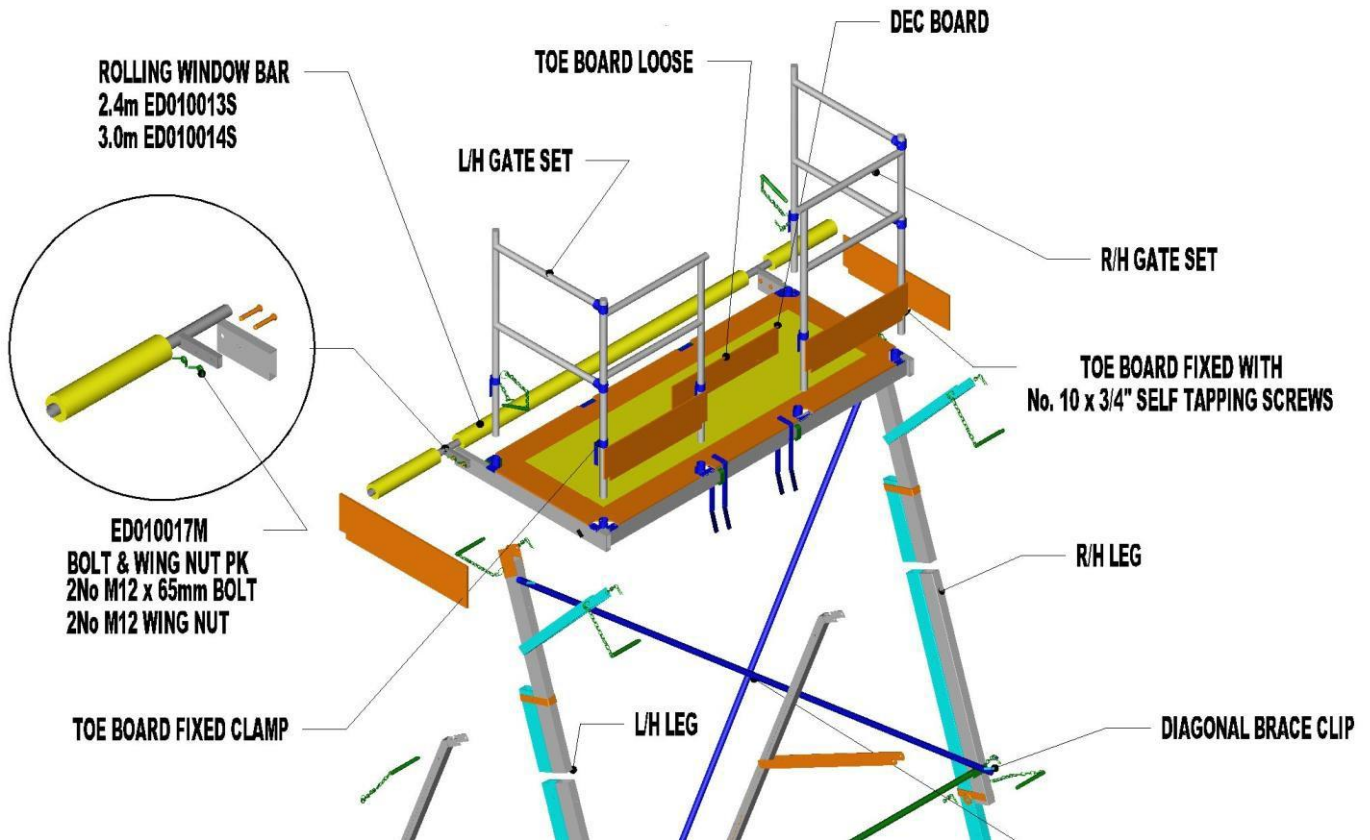

EXPLODED DIAGRAM OF - 2M EASI-DEC COMPLETE -ED010001A WITH ROLLING WINDOW BAR



The component parts depicted for the 2m Easi-Dec with Rolling bar have the following names and functions:

Item	Name	Function	Quantity
ED01001A	2m Easi-Dec Platform. 	<ul style="list-style-type: none"> 2m Easi-Dec Platform complete with wheels. Total Weight=78kg (approx.) 	1 piece

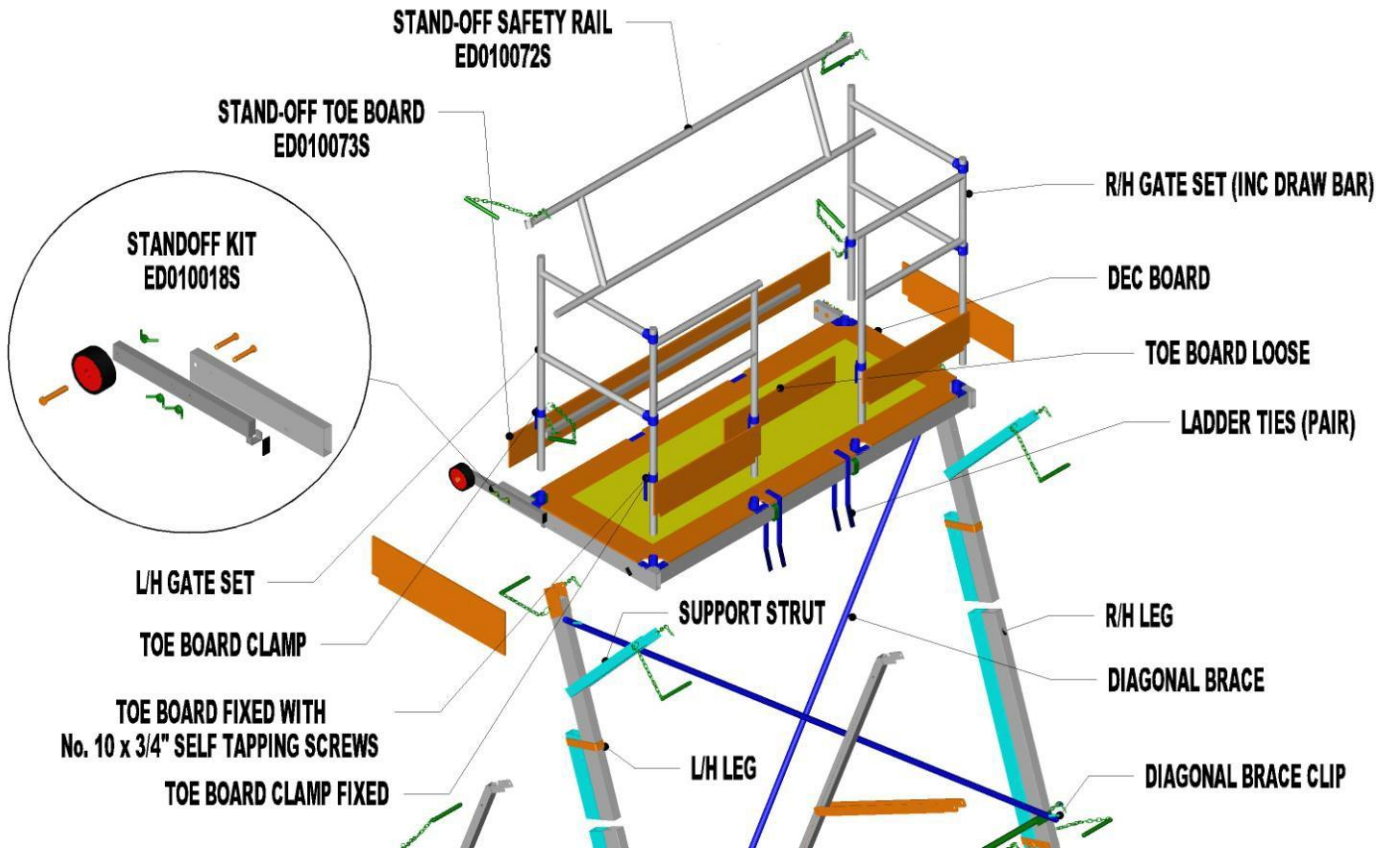

<p>ED010013S</p>	<p>Rolling Window Bar 2.4m Kit</p> 	<ul style="list-style-type: none"> • Provides a continuous 2.4m platform support for load distribution. Particularly useful on claddings, tiled hangings and rendered substrates. • Allows Easi-Dec to be rolled over a window during erection positioned against the mullions of a window where necessary • Supplied with Bolts and wing nuts for easy assembly. • Total weight =4kg (approx.) 	<p>1 piece</p>
<p>ED010017M</p>	<p>Bolt & Wing Set</p> 	<ul style="list-style-type: none"> • Accessories, Bolt & Wing set for Rolling Window Bar <p>Total Weight =0.06kg (approx.)</p>	<p>1 piece</p>

EXPLODED DIAGRAM OF - 2M EASI-DEC COMPLETE -ED010001A WITH STAND-OFF KIT

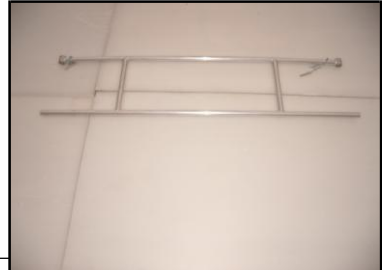

The component parts depicted for the 2m Easi-Dec with Stand-off kit have the following names and functions:

Item	Name	Function	Quantity
ED010001A	2m Easi-Dec Platform. 	<ul style="list-style-type: none"> 2m Easi-Dec Platform complete with wheels. Total Weight=78kg (approx.) 	1 piece

<p>ED010018S</p>	<p>Stand-off kit</p> 	<p>The stand-off arms enable the platform to be positioned away from the building.</p> <p>A pair of 200mm stand-off arms are fitted to the platforms front horns' with bolts and wing nuts.</p> <p>Front rail, Upright, Toe-Board and stand-off arms in the Kit</p> <p>Total weight =8kg (approx.)</p>	<p>1 piece</p>
<p>ED010072S</p>	<p>Stand-off front Guard Rail</p> 	<p>Guard rail prevents user falling through increased stand-off gap.</p> <p>Connect using Pin and „R' clips</p> <p>Total weight =2.6kg (approx.)</p>	<p>1 piece</p>
<p>ED010073S</p>	<p>Stiffened stand-off Toe-Board</p> 	<p>2m Long Plywood Toe-Board with aluminum Stiffening bar.</p> <p>Fix into Position and slide Clamp over Toe-Board clips</p> <p>Total Weight =2.4kg (approx.)</p>	<p>1 piece</p>
<p>ED010074S</p>	<p>Stand-offs 200mm (Handed Pair) –Arms only</p> 	<ul style="list-style-type: none"> • Stand-off arms • Weight = 2kg (approx.) 	<p>1 pair</p>

EXPLODED DIAGRAM OF - (2.5m WINDOW DEC (ED010005A))

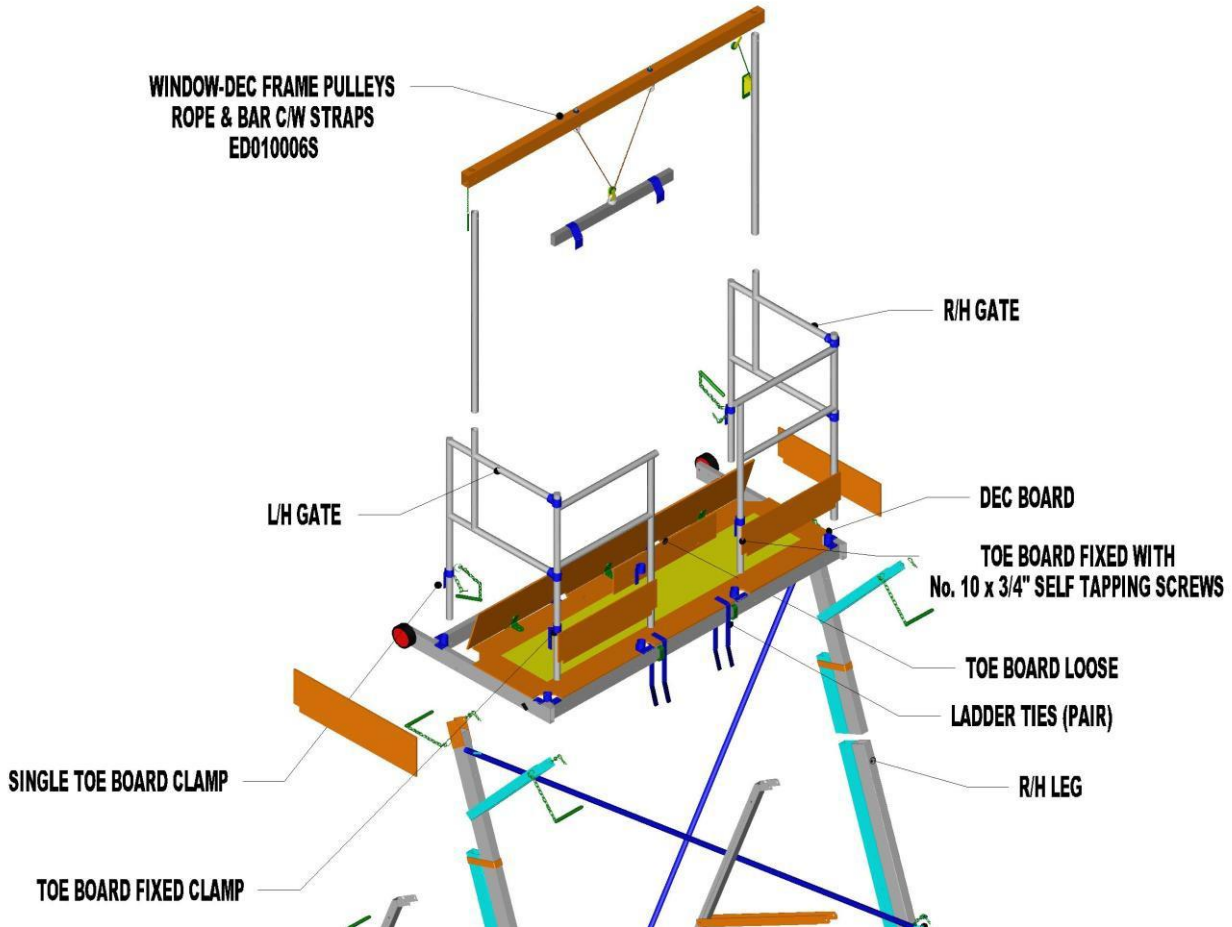

The component parts depicted for the 2.5m Window Dec have the following names and functions:

Item	Name	Function	Quantity
ED010003A	2.5m Window-Dec 	<p>The Window Dec is fitted in two parts to provide a hinged opening allowing the item being hoisted to pass through the platform and safely onto it.</p> <ul style="list-style-type: none"> Dec measuring 2500mm x 800mm (Including Hatch) with a pair of wheels. <p>Total Weight=85kg (approx.)</p>	1 pieces

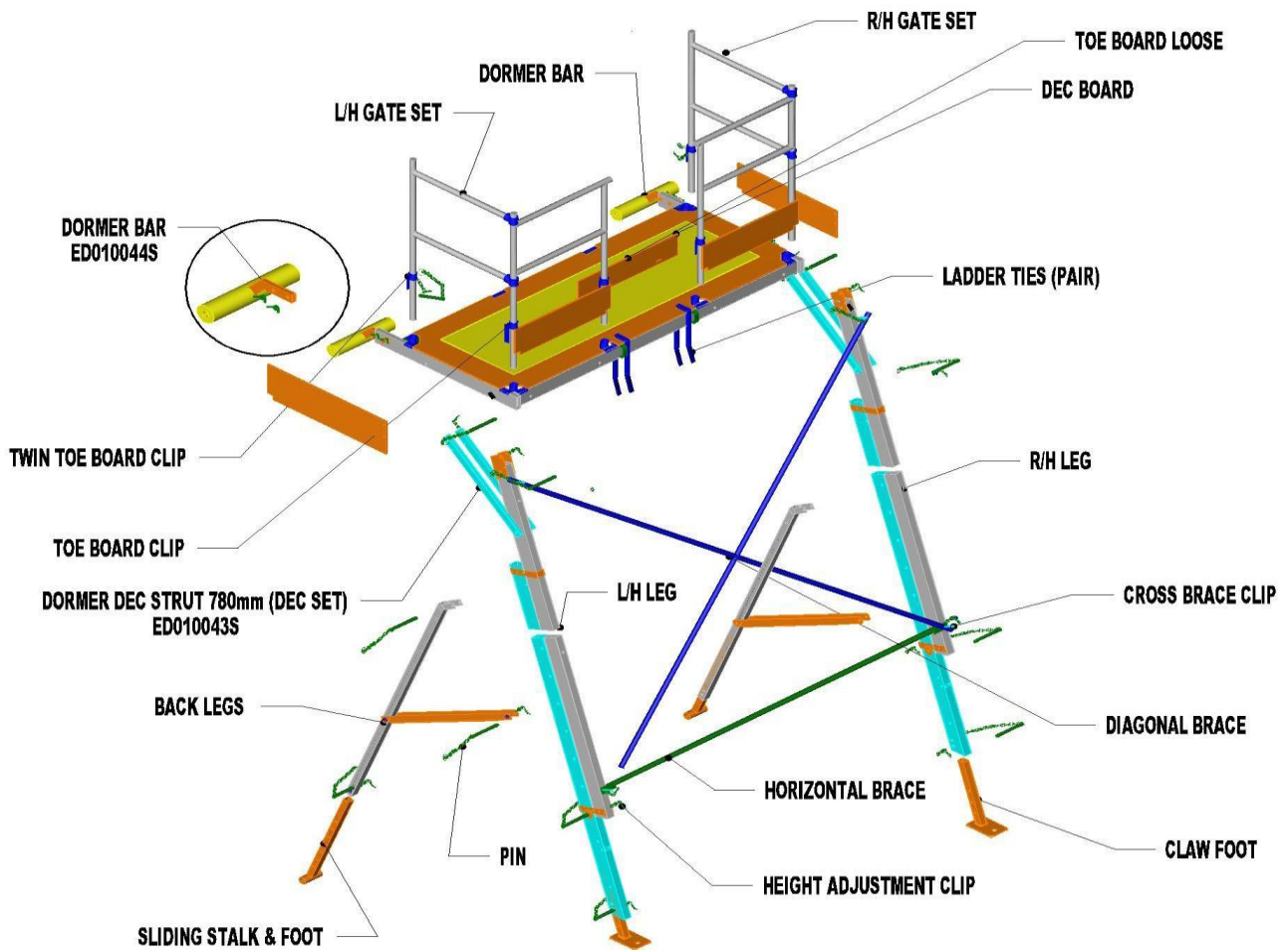

<p>ED010006S</p>	<p><i>Window-Dec, Frame, Pulleys Rope & Bar C/W Straps</i></p> 	<ul style="list-style-type: none"> • The Lifting Mechanism consists of a rope, pulley and safety clutch suspended from an overhead lifting beam mounted on Guard Rails. • Frame connected to Guard rail telescopically with self-locking Pins. • Total weight =8kg (approx.) 	<p>1 pieces</p>
------------------	---	---	-----------------

2M EASI-DEC WITH DORMER KIT



The component parts depicted for the 2m Easi-Dec with Dormer kit have the following names and functions:

Item	Name	Function	Quantity
ED010001A	2m Easi-Dec Platform. 	<ul style="list-style-type: none"> 2m Easi-Dec Platform complete with wheels. Total Weight=78kg (approx.) 	1 piece

ED010043S	<p>Dormer Dec struts</p> 	<ul style="list-style-type: none"> • Dormer Dec strut 780mm, connect using pin and „R“ clip form outside in. • Total Weight =3.2kg (approx.) 	2 pair
ED010044S	<p>Dormer Padded bars</p> 	<ul style="list-style-type: none"> • Used to protect tiles from damage and support dormers. • Fit the Dormer bars to the inside of the bottom platform using bolts and wing nuts. • Second platform fit dormer bars to the outside of the platform „horns“. • Total weight =2.4kg (approx.) 	1 pair

DOUBLE DORMER SETUP

EXPLODED DIAGRAM OF 2 METRE EASI-DEC WITH A SECOND PLATFORM FITTED

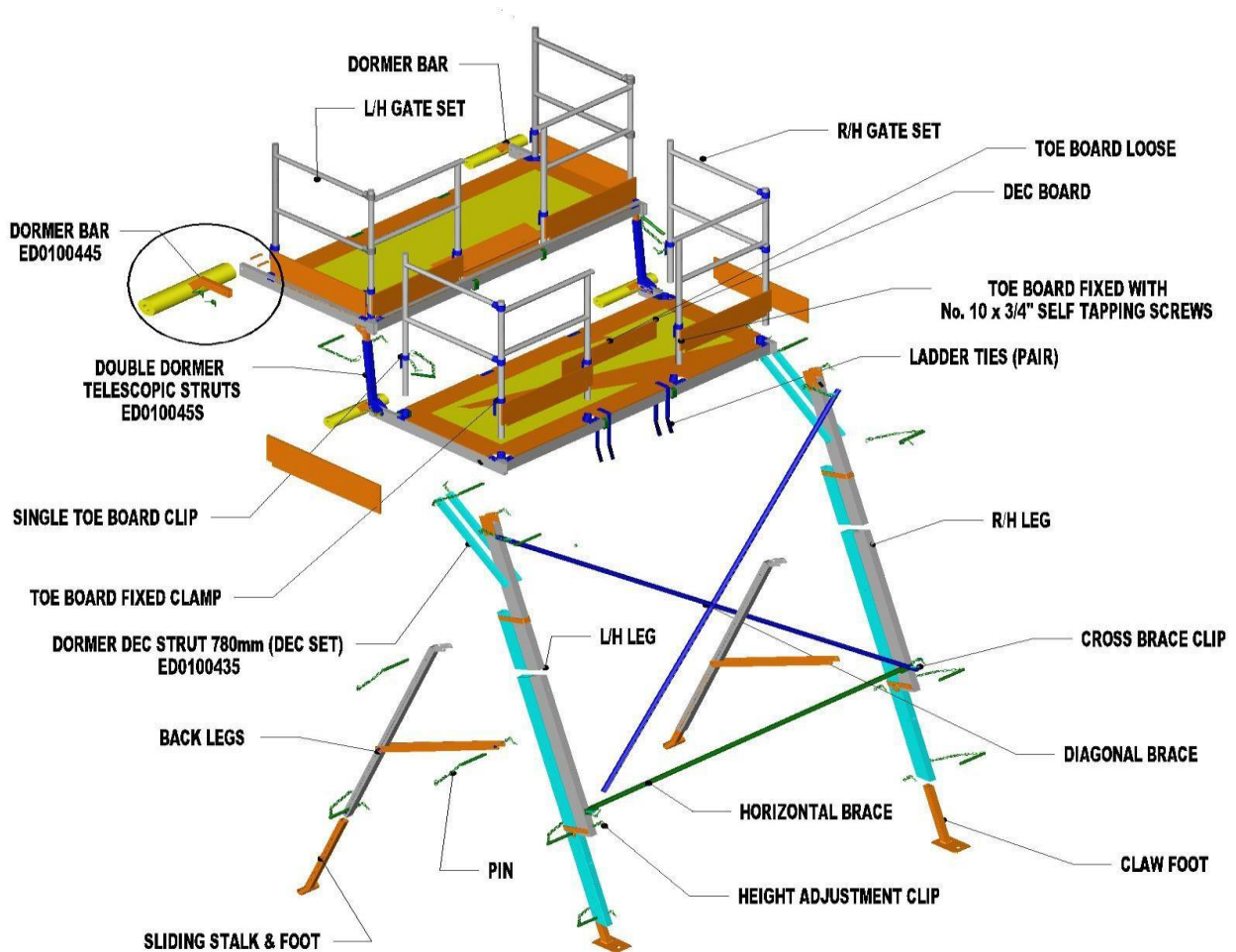

The component parts depicted for the Double Dormer have the following names and functions:

Item	Name	Function	Quantity
ED010001A	2m Easi-Dec Platform. 	<ul style="list-style-type: none"> 2m Easi-Dec Platform complete with wheels. Total Weight=78kg (approx.) 	2 pieces

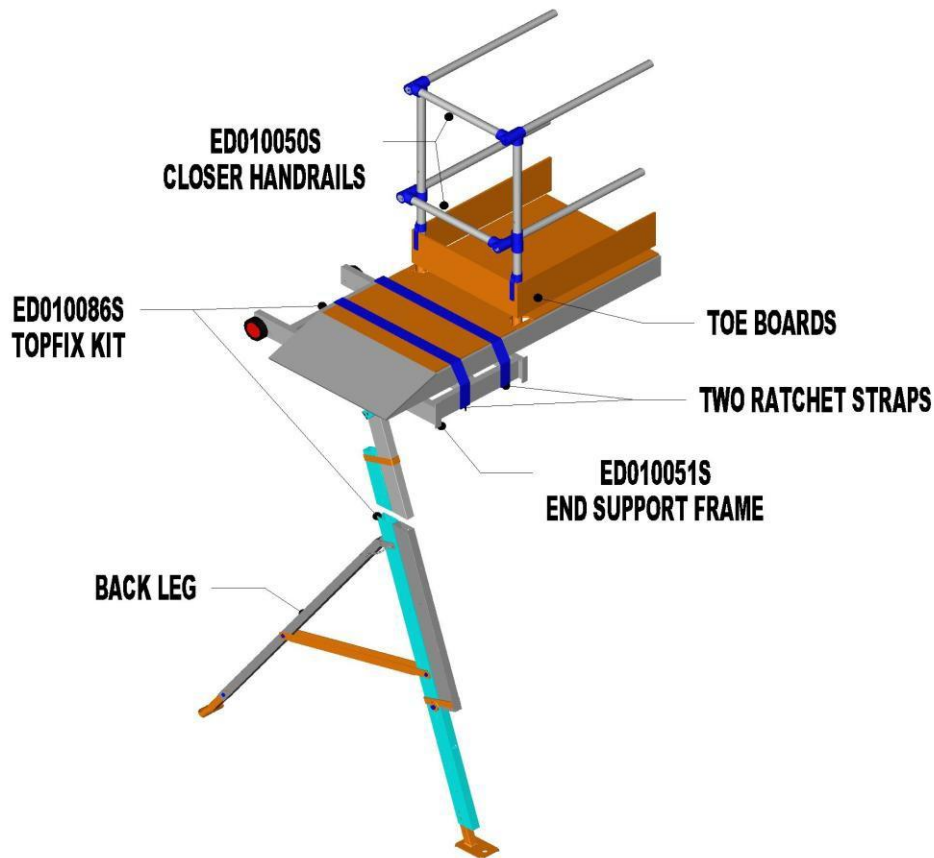

<p>ED010039S</p>	<p>Double dormer Kit</p> 	<p>Full conversation Kit to evolve platforms into Double Dormers.</p> <p>Total Weight =7kg (approx.)</p>	<p>1 piece</p>
<p>ED010043S</p>	<p>Dormer Dec struts</p> 	<p>Dormer Dec strut 780mm, connect using pin and „R“ clip form outside in.</p> <p>Total Weight =3.2kg (approx.)</p>	<p>2 pair</p>
<p>ED010044S</p>	<p>Dormer Padded bars</p> 	<p>Used to protect tiles from damage and support dormers.</p> <p>Fit the Dormer bars to the inside of the bottom platform using bolts and wing nuts.</p> <p>Second platform fit dormer bars to the outside of the platform horns'.</p> <p>Total weight =2.4kg (approx.)</p>	<p>1 pair</p>
<p>ED010045S</p>	<p>Double Dormer Telescopic Struts.</p> 	<p>Used to connect both platforms together.</p> <p>Adjustable in order to level the platform to suit a roof pitch of 30-40 Degrees</p> <p>Total weight =3.8kg (approx.)</p>	<p>1 pair</p>

END SUPPORT FRAME

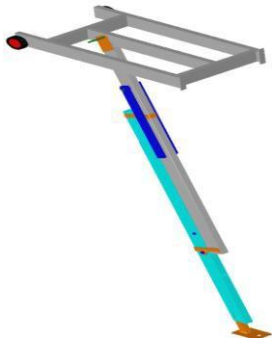

The component parts depicted for the End support Frame have the following names and functions:

Item	Name	Function	Quantity
ED010051S	End Support Frame with Leg 	<p>The support frame and single leg are designed to support one end of a Catwalk staging where there is insufficient space to accommodate a 2m Easi-Dec.</p> <p>Can be used as additional support for centre of the Catwalk to increase the Load capacity (150kgs)</p> <p>Total Weight=22kg approx</p>	1 piece



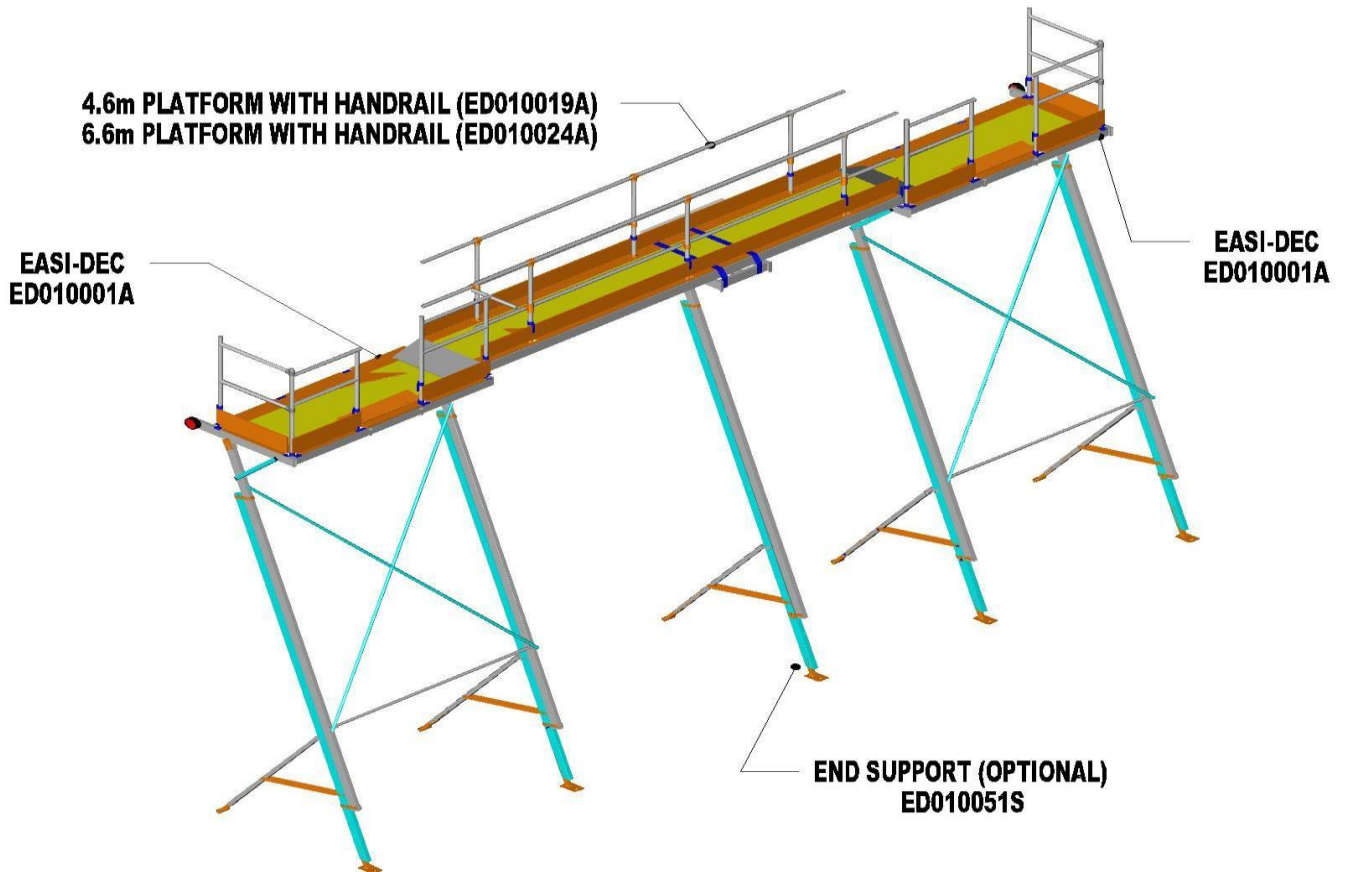

<p>ED010086S</p>	<p>Top Fix Kit (Includes Drill, Eyebolt & Plastic plugs)</p> 	<ul style="list-style-type: none"> • Always tie the End Support Frame to the wall with the top fix kit. • Total weight =0.5kg approx 	<p>1 piece</p>
<p>ED010050S</p>	<p>Closer handrails & Toe Board</p> 	<ul style="list-style-type: none"> • Fit the top & mid-rail by tightening the grub screws. • Secure the Loose Toe-Board with the Toe-Board Clamps 	<p>1 piece</p>



2 x EASI-DEC AND CATWALK ASSEMBLY (4.6m & 6.6m)



The component parts depicted for the 2 x Dec and Catwalk Assembly have the following names and functions:

Item	Name	Function	Quantity
ED010001A	2m Easi-Dec Platform. 	<ul style="list-style-type: none"> • 2m Easi-Dec Platform complete with wheels. • Total Weight=78kg approx 	2 piece

ED010019A	<p>Cat Walk 4.6m including Handrail</p> 	<p>Catwalk 4m to form a bridge between two Easi-Decs. (8m platform)</p> <p>Includes 1 set of handrails & toe boards (4 pieces)</p> <p>Total Weight = 62Kg (approx.)</p>	<p>1 piece (8m Roofline System)</p>
ED010020A	<p>Cat Walk 6.6m including Handrail (AS THE 4.6M BUT 6.6M LONG AND NO RAMPS)</p>	<p>Catwalk 6.6m to form a bridge between two Easi-Decs. (10m platform)</p> <p>Total Weight = 90Kg (approx.)</p>	<p>Optional (10m Roofline System)</p>
ED010021S	<p>Cat Walk 4.6m Mid Handrail</p> 	<p>Mid-Rail for 4.6m Catwalks. (cross brackets x 3)</p> <p>Total Weight=2.6kg (approx.)</p>	<p>2 piece</p>
ED010022S	<p>Cat Walk 4.6m Top Handrail</p> 	<p>Top handrail for 4.6m Catwalks. ('T' brackets x 3)</p> <p>Total Weight=3kg (approx.)</p>	<p>2 piece</p>
ED010023S	<p>Cat Walk 4.6m Long.</p> 	<p>Catwalk 4.6m no Handrails included.</p> <p>Total Weight=35kg (approx.)</p>	<p>1 piece</p>
ED010024A	<p>Catwalk 6.6m complete Fixed Board (Weight 71kg approx.)</p>	<p>Catwalk 6.6m to form a bridge between two Easi-Decs complete with FIXED Boards.</p>	
ED010025A	<p>Catwalk 6.6m complete Loose Boards. (Weight 50kg approx. no boards)</p>	<p>Extended Catwalk 6.6m to form a bridge between two Easi-Decs complete with LOOSE boards</p>	
ED010026S	<p>Cat Walk 6.6m Mid Handrail</p>	<p>Mid-Rail for 6.6m Catwalks.</p> <p>Total Weight=2.7kg (approx.)</p>	
ED010028S	<p>Cat Walk 6.6m Top Handrail</p>	<p>Top-Rail for 6.6m Catwalks.</p> <p>Total Weight = 3.5Kg (approx.)</p>	
ED010027S	<p>Catwalk 6.6m No Handrails</p>	<p>Catwalk 6.6m to form a bridge between two Easi-Decs no handrails.</p>	

ED010029s	Catwalk Handrail only 4.6m two sided including posts, rails and Toe- Boards.	<ul style="list-style-type: none"> • 2 sided handrail complete. <p>Total Weight=26.5kg (approx.)</p>	1 set
ED010030S	Catwalk Handrail only 6.6m two sided including c/w uprights and Toe Boards.	<ul style="list-style-type: none"> • C/w uprights and toe-boards 	
ED010031S	Catwalk Handrails 4.6m one sided c/w uprights and toe-boards.	<ul style="list-style-type: none"> • c/w uprights and toe-boards <p>Total Weight=13.25kg (approx.)</p>	
ED010032S	Cat Walk Handrails 6.6m one sided c/w uprights and toe-board.	<ul style="list-style-type: none"> • c/w uprights and toe-boards 	
ED010033S	Cat Walk upright post (End) 	<ul style="list-style-type: none"> • End uprights positioned both ends of the catwalk. <p>Total Weight=1.0kg (approx.)</p>	4 piece
ED010034S	Catwalk upright post (Mid)	<ul style="list-style-type: none"> • Positioned between the End uprights. 	2 piece
ED010077A	Lanyard c/w 1No Karabiner+Hook	<ul style="list-style-type: none"> • To restrict stepping over the edge of the platform when fitting the Catwalk 	2 piece
ED010085S	Twin Toe-Board clamp 	<ul style="list-style-type: none"> • Dual direction Toe-Board clamp for clamp over connection of Toe-Board • Total weight =0.2kg (approx.) <p>Note: Always fit Toe-Boards and guardrails at lowest height.</p>	4 piece

TRIMLINE 6m SYSTEM (ED010011A)

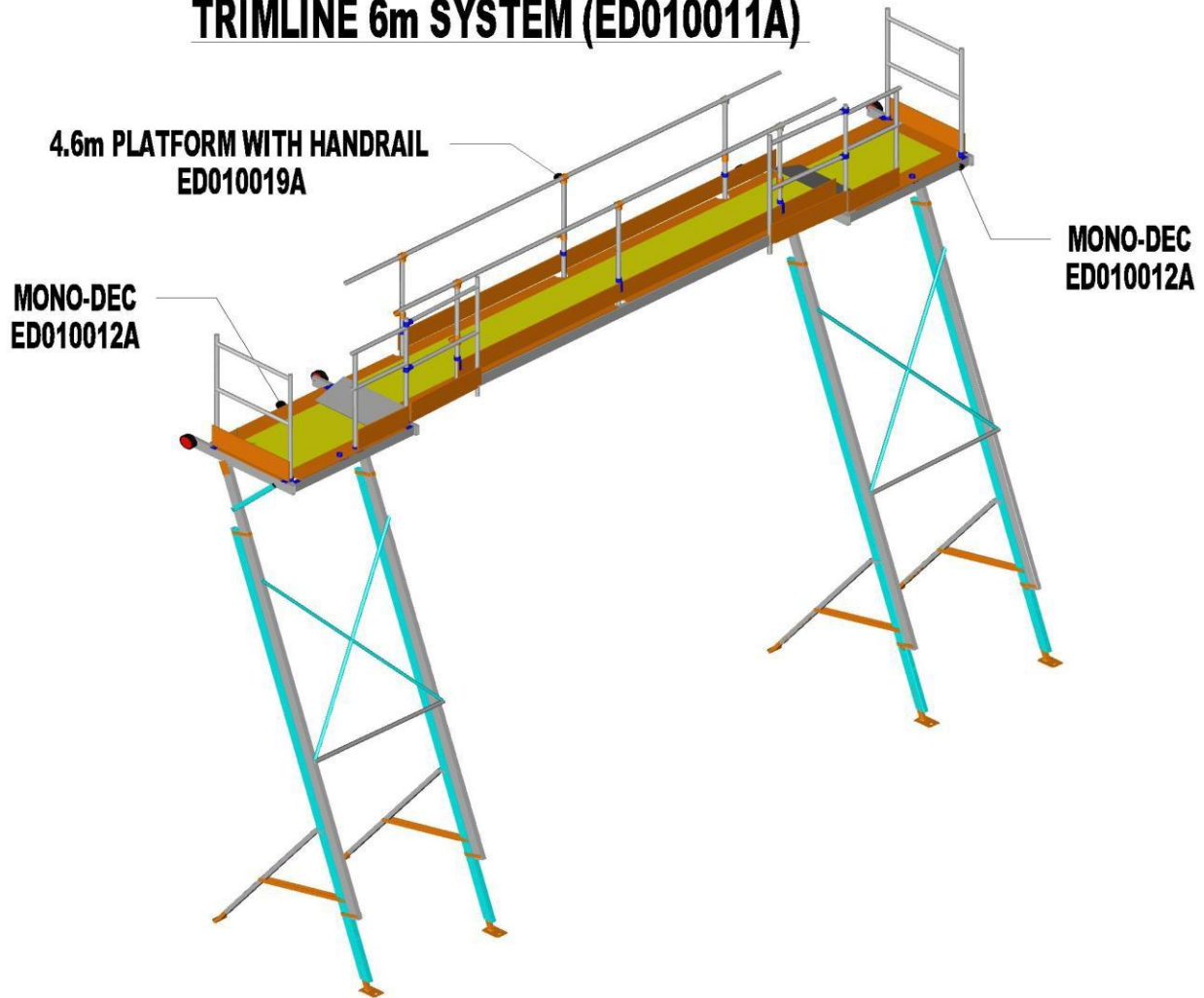

The component parts depicted for the Trimline 6m System have the following names and functions:

Item	Name	Function	Quantity
ED010011A	TrimLine 6m system complete. 	2 x Mono - Dec's with 4.6m Catwalk complete. Weight = 188kg (approx.)	1 piece

ED010012A	<p>Mono-Dec single</p> 	<ul style="list-style-type: none"> • 1200mm x 600mm Mono-Dec complete. <p>Weight = 63kg (approx.)</p>	1 piece
ED010019A	<p>Cat Walk 4.6m including Handrail</p> 	<ul style="list-style-type: none"> • Catwalk 4.6m to form a bridge between two Mono-Decs. <p>Weight = 62kg (approx.)</p>	1 piece
ED010021S	<p>Cat Walk 4.6m mid Handrail</p>	<ul style="list-style-type: none"> • Mid-Rail for 4.6m Catwalks. • Total Weight=2.6kg (approx.) 	1 piece
ED010022S	<p>Cat Walk 4.6m Top Handrail</p>	<ul style="list-style-type: none"> • Top handrail for 4.6m Catwalks. • Total Weight=3kg (approx.) 	1 piece
ED010023S	<p>Cat Walk 4.6m Long.</p>	<ul style="list-style-type: none"> • Catwalk 4.6m no Handrails included. • Total Weight=20kg (approx.) 	1 piece
ED010031S	<p>Catwalk Handrails 4.6m one sided c/w uprights and toe-boards.</p>	<ul style="list-style-type: none"> • c/w uprights and toe-boards <p>Total Weight=13.25kg (approx.)</p>	1 piece
ED010077A	<p>Lanyard c/w 1 No Karabiner & Hook</p>	<ul style="list-style-type: none"> • To prevent a fall from Height. 	1 piece



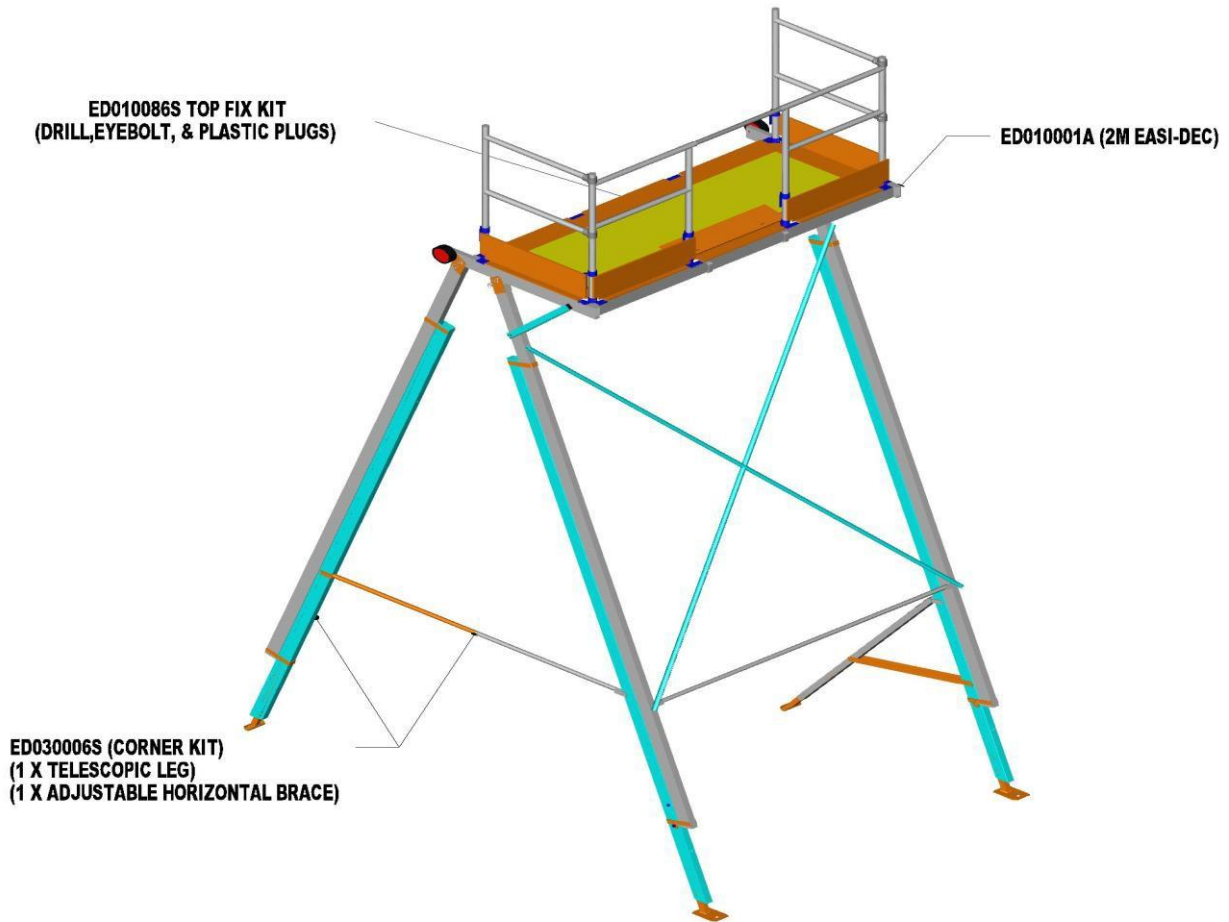

2M EASI-DEC - WITH CORNER KIT.



The component parts depicted for the 2m Easi-Dec with Corner Kit have the following names and functions:

Item	Name	Function	Quantity
ED010001A	2m Easi-Dec Platform. 	<ul style="list-style-type: none"> 2m Easi-Dec Platform complete with wheels. Total Weight=78kg (approx.) 	1 piece
ED030006S	Corner Kit.	<ul style="list-style-type: none"> The Corner Kit consists of a single Telescopic Platform Leg and Horizontal Brace. 	1 piece

		<p>The Corner Leg is fitted to one end of the Platform enabling it to be erected overhanging the corner of a building.</p> <p>Total weight = 11Kg (approx.)</p>	
<p>ED010038S</p>	<p>Corner Leg Brace</p> 	<ul style="list-style-type: none"> • Adjustable Horizontal Brace • Total Weight =2.8kg (approx.) 	<p>1 piece</p>
<p>ED010086S</p>	<p>Top Fix Kit (Includes Drill, Eyebolt & Plastic plugs)</p> 	<ul style="list-style-type: none"> • To secure Dec to the wall. • Total weight =0.5kg (approx.) 	<p>1 piece</p>

Selecting the Installation Site

Contents

Requirements of the installation site.



Danger!

The installation site can affect the safe functioning of the Easi-Dec Platform & Roofline System. If the requirements of the installation site are not met, do not use the system unless of a comprehensive check of site conditions.

Requirements of the Installation Site

The installation site must meet the following requirements:

Criterion	Requirement
Overhead structures	<ul style="list-style-type: none"> • Be-Aware of Overhead structures which the operator could be crushed against and the interference of overhead power cables.
Meteorological conditions	<ul style="list-style-type: none"> • The platform must be free from snow and ice. • If, during use, there is a risk of freezing conditions or if it starts to snow, the Easi-Dec & Roofline System may not be used. • The Easi-Dec Platform & Roofline System may not be used in conditions of high winds more than 23mph.
Safety distances	<ul style="list-style-type: none"> • The correct angle at rest for Ladder is 75 Degrees, or a base to height ratio of 1:4
Ground Surfaces	<ul style="list-style-type: none"> • Care should be taken with localised ground features, such as trenches, manholes and un-compacted backfill, which could lead to overturning.

Positioning the 2m Easi-Dec platform



- When lifting the platform up against the wall use bent legs and a straight back, firstly to waist height then, using your arms, offer the platform to the wall and roll it up into position. Pay particular attention to the balance of the Easi-Dec, the positioning of the hands and the way the Claw foot Grips whilst taking a second handhold.
- Always maintain full support until the Foot has adequate grip.
- Level the platform in both directions, with fine adjustment with the Foot and coarse adjustment with the Leg. **REMEMBER** to adjust the feet away from the wall in order to level the platform.
- Fit the *Back Legs*, remove the middle *Pin* first, holding on to it, but lowering the *Brace*. Next remove the top *Pin* and fit to the main *Leg* at about eye level. When fitting the *Brace*, the objective is to position the *Foot* as close to the wall as possible without it fouling the wall, or touching the ground. Fit the *Brace* accordingly. Finally adjust the feet accordingly, allowing a finger's clearance under them, to ensure the *Easi-Dec* remains in contact with the wall.
- The ladder should be placed against the *Platform*, extended 1 metre above the platform and placed between the *Ladder Ties* but to the right hand side (**Note when tied in place, enough room should be available to step through the gap on the left hand side**). With the ladder footed or using a suitable Ladder Safety Device, such as *Easi-Dec Ladder Spurs*, climb the Ladder and tie on using the *Ladder Ties* provided.

- When carrying the left and right *Guard-rails* up the ladder, you must maintain three points of contact whenever possible to prevent a fall. Always fit the guardrails with one arm between the rung of the ladder and position in the front locating sockets of the platform.

(Note this is why the ladder needs to project above *Platform*, to provide a handhold and guard).

- Fit the *Guard-rails* into the sockets and fix with the *Pin* and '*R*' *Clips*. Finally close the *Draw Bar*.

(Note the *Guard-rails* should always be fitted with the *Platform* at its lowest practical level, to minimize any risk when carrying the *Guard-rails* up the ladder).

- Having fitted the *Guard-rails*, the height of the *Platform* may now be adjusted to one more suitable for the work in hand.

(Note this will involve removal and readjustment of the *Ladder* and the *Back Legs*).

- Reposition the ladder to mid-rail height allowing safe working access to the platform.
REMEMBER to tie-on the ladder to the platform.

Safety Precautions - Erecting

- **Always** take particular care, throughout the erection procedure, especially the assessment of Site/Weather Conditions, overhead power lines etc., prior to assembly and use.
- **Always** ensure all Pins and „R' Clips are correctly fitted and secure, with the „R' Clips on the inside.
- **Always** level the Platform in both directions.
- **Always** use the Back Legs. Top fixing or staking of the feet should also be considered where site conditions or circumstances dictate.
- **Always** fit Safety Guard-rails and Toe Boards at the lowest height.
- **Always** follow the 4:1 rule when erecting the ladder. It should be 1m above the Dec during Guard-rail installation, Mid Rail height during use, and Tied Off using the straps provided. Always maintain at least three points of contact when climbing the ladder.
- **Always** check for Overhead power cables and obstructions
- To comply with the BS EN 12811 & EN13374 then the Dec needs to be tied into the structure; however a risk assessment should to be undertaken in all instances to ascertain the correct procedure.

Remember: always tie the Dec(s) into the structure if used as edge protection.

- **Always** check all aspects of the Easi-Dec Platform, before using if the equipment is left unattended for any period of time.
- It is important when handling the Easi-Dec products in hot weather, that the appropriate PPE is used for resistance against thermal heating of the materials.
- **Never** use against green/fresh brickwork.
- **Never** use in high winds – maximum 17mph without tying.
- **Never** exceed the maximum distributed load of 300 Kg per platform.
- Never use a ladder or stepladder to gain extra height from the Platform.

Dismantle / Lift & Shift.

- To dismantle, adjust the ladder to one metre above the Platform and tie on.
- Having three points of contact on the ladder, remove the Guardrails and carry them down to ground level.
- After removing the Guardrails, the back legs and adjusting to the lowest height, find the centre of balance of the platform and shuffle the platform into position.
- Always keep the platform close to the wall when shifting it. If site conditions are awkward then the Easi-dec should be fully dismantled.
- To continue dismantling allow the leg to slide through your hands, when rolling the Easi-Dec down the wall, to maintain balance at its centre of gravity and lower it safely to the ground.
- When removing the legs “park the pins, Diagonal braces and Dec support properly in order to care for the equipment.

Safety precautions – Dismantling

- **Always** carry Easi-Dec at its lowest height
- Stay close to the wall when “Lifting and shifting”
- **Always** stay close to the wall, when rolling it down to control the descent of the platform.

Installing the 2m Easi-Dec Platform with Rolling Window Bar.

Attaching, the Rolling Window Bar.

- Remove the Wheels, from the Platform horns, and fit the Rolling Window Bar using the four Bolts and Wing Nuts provided. See **FIG 1**. Note, it is also possible to fit the Rolling Window Bar to the Standoff Arms – remove the wheels and the black Plastic Stop Ends from the Arms, and the Bolts, Wing Nuts from the stalks of the Rolling Window Bar. Fully insert the stalks inside the stand-off arms and use one Bolt and Wing Nut either side to fix in place. (**Note remember to store the Plastic Stop Ends and the Wheels carefully for future use**).

FIG 1. - Attaching the Window Bar.

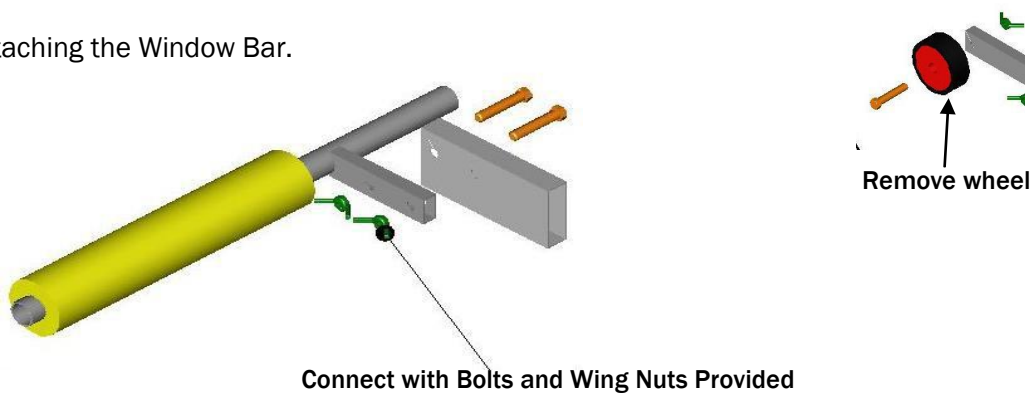

Positioning the 2m Dec, with Rolling Window Bar.



- Use in the same way as the Easi-Dec described in „The 2 metre Easi-Dec Platform’ Erection/Dismantle procedure.
- To dismantle reverse this procedure.

Safety precautions

- Always** take care when rolling the platform over delicate surfaces.
- Always** bridge at least two mullions when it is necessary to position the platform over a window to minimize the load on the glass. The operative must be responsible for assessing the site conditions in these cases.

Installing the 2m Easi-Dec Platform with the Stand-off kit.

Attaching the Stand-off Kit

Remove any accessory, attached to the Platform Horns, and fit the Standoff Arms. Refit the Wheels or Rolling Window Bar to the ends of the Standoff Arms. See **FIG 2**. (Note if using the Rolling Window Bar, remove the black Stop-Ends from the Standoff Arms, fully insert the stalks inside the stand-off arms and use one Bolt and Wing Nut either side to fix in place. Keep the spare Bolts, Wing Nuts and Wheels in a safe place for future use).

FIG 2. - Attaching the Stand-off Kit

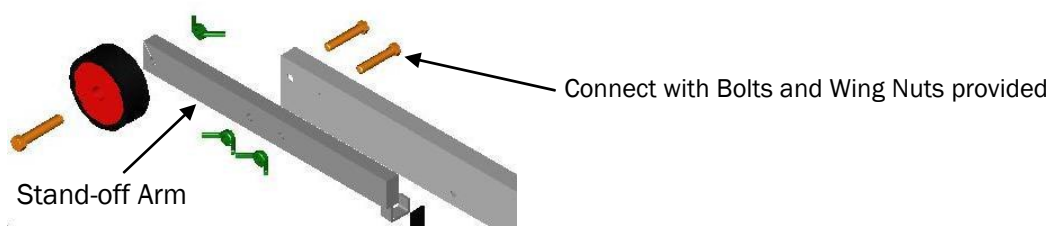

Positioning the 2m Dec, with Stand-off Arms.



- Use in the same way as the Easi-Dec described in „The 2 metre Easi-Dec Platform’ Erection/Dismantle procedure.
- After fitting the Guardrails, the increased gap between the wall and the platform must be protected. The Front Handrail and Toe-Board are fitted for this purpose.
- When Easi-Dec is used to support a Catwalk, an additional upright post is supplied to provide support for the Front handrail and toe board because the End Guard-rail is left open to accommodate the Catwalk.

Safety precautions

- **Never** board over the stand-off arms to create more working area.
- **Always** use front Handrail and Toe Board.

Positioning the Dormer Dec

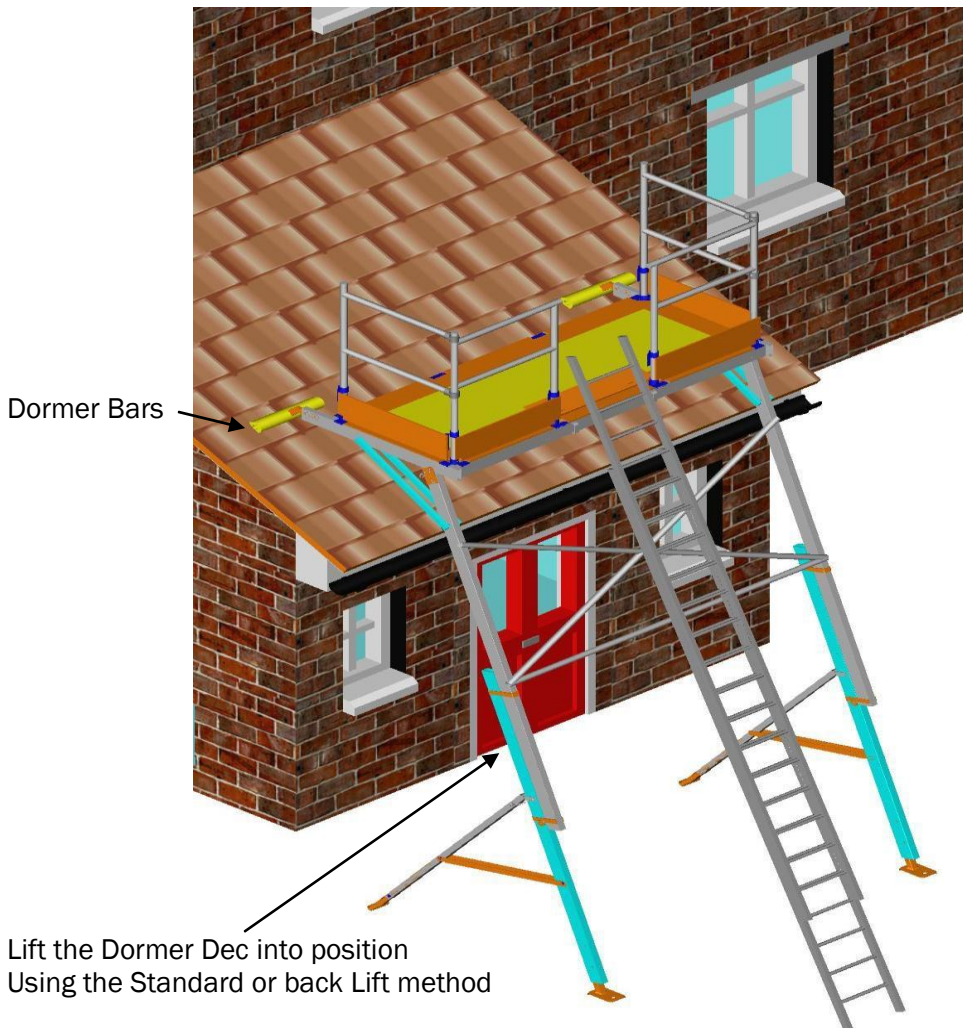

Erecting Procedure the Dormer Kit

- Two methods of erection may be considered

Standard Method

- Erect the Platform just under the eaves, but with the feet **“much further away”** from the wall than usual. With your back to the wall, push the Leg to bring the Platform clear of the eaves so the Dormer Bars are above the gutter. With the legs near vertical, bring the feet closer to the building and allow the padded bars to settle onto the roof. It is now very easy to adjust the length of the legs to level the Platform, because the roof will support the Dormer-Dec.

Back - Lift Method

- Assemble the Dormer-Dec on the floor but this time with the feet at the floor/wall juncture, and the Platform with the Dormer Bars uppermost. Pick up the Platform high enough to pass your hands from the Platform carefully on to the Legs and walking towards the wall push the Legs up in front of you. When the Dormer-Dec is against the wall, lift the feet clear of the ground and position them away from the wall keeping the padded bars in contact with the wall. Continue as in the standard method.
- When working on low roofs, the back lift method may allow the dormer bars to be positioned onto the roof at the first lift.

Dismantle

- To dismantle reverse this procedure.
- If the Back-lift method has been used it is recommended to dismantle following the standard method, that is, bring the Platform down the wall and not overhead.

Safety Precautions

- The Back-lift method will require additional help and extra care should be taken to avoid over balancing.
- Follow the Easi-Dec platform Safety guidelines.

Positioning the Double Dormer Kit.

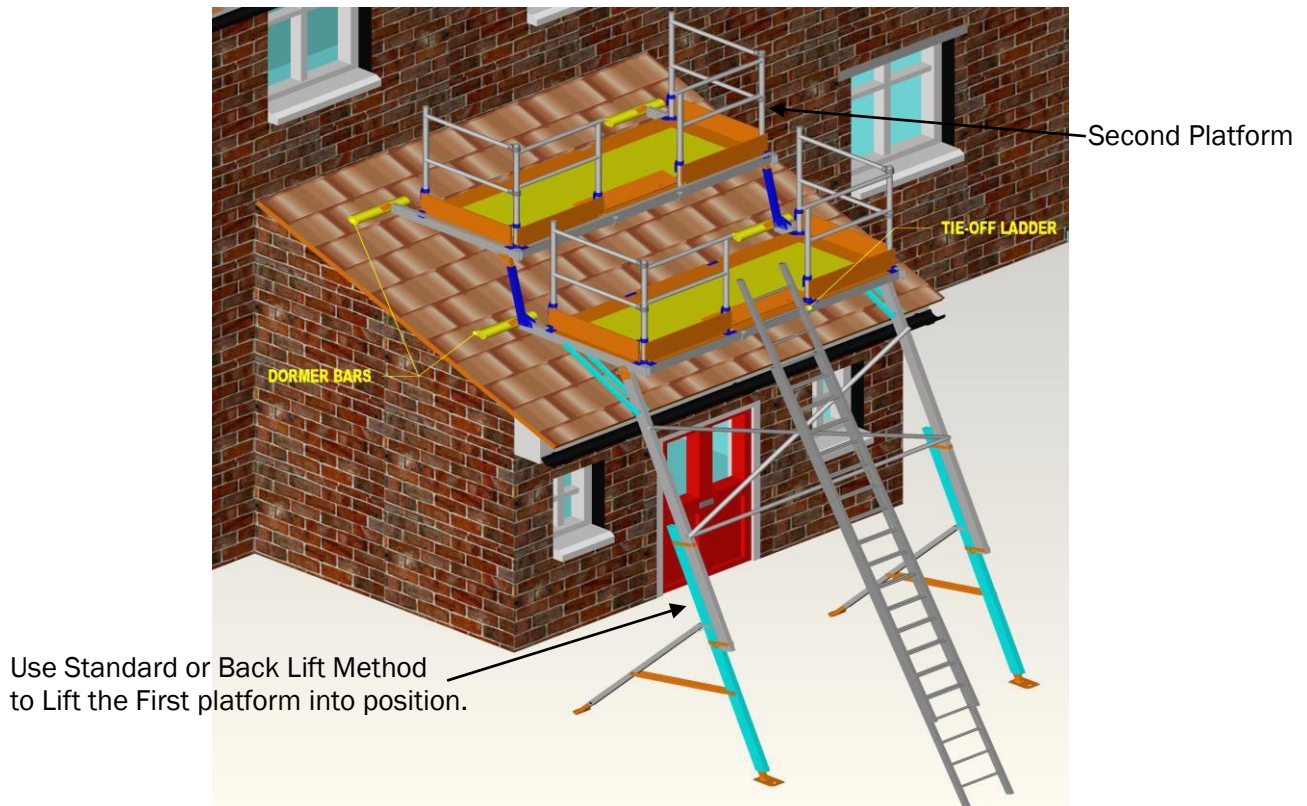

Erecting Procedure the Double Dormer Kit

- Two methods of erection may be considered

Standard Method

- Erect the Platform just under the eaves, but with the feet “**much further away**” from the wall than usual. With your back to the wall, push the Leg to bring the Platform clear of the eaves so the Dormer Bars are above the gutter. With the legs near vertical, bring the feet closer to the building and allow the padded bars to settle onto the roof. It is now very easy to adjust the length of the legs to level the Platform, because the roof will support the Easi-Dec.

Back - Lift Method

- Assemble the Easi-Dec Platform on the floor but this time with the feet at the floor/wall juncture, and the Platform with the Dormer Bars uppermost. Pick up the Platform high enough to pass your hands from the Platform carefully on to the Legs and walking towards the wall push the Legs up in front of you. When the Easi-Dec is against the wall, lift the feet clear of the ground and position them away from the wall keeping the padded bars in contact with the wall. Continue as in the standard method.
- When working on low roofs, the back lift method may allow the dormer bars to be positioned onto the roof at the first lift.
- Fit the Guard-rail before fitting the second Platform.
- After using one of the two lifting methods for the first platform the second platform then needs to be lifted up into position. This is done with both operatives safely positioned on the guarded platform. The second platform is towed up to the first using straps tied to the padded bars, and the ladder as a guide.

Safety Precautions

- In theory any number of platforms could be added, creating a “Stairway” up the roof. However with three or more platforms the first platform must **always** be tied in to the structure, as well as using the Back Legs.
- The Back-lift method will require additional help and extra care should be taken to avoid over balancing.
- **Always** check for Overhead power cables and obstructions
- **Never** use against green/fresh brickwork.
- **Never** exceed the maximum distributed load of 300 Kg per platform.
- **Never** use a ladder or stepladder to gain extra height from the Platform.
- **Always** tie off the Dec to the structure with a suitable anchor for the base material and make sure it is installed correctly as per manufacturers instruction.
- It is important when handling the Easi-Dec products in hot weather, that the appropriate PPE is used for resistance against thermal heating of the materials.

Positioning the 2m Easi-Dec with Corner Kit



Erection Procedure for the Corner Dec

- Fit the standard legs to the platform in the usual way. The corner leg is now fitted to the spare hole behind the wheel on the Dec horn on the appropriate side. This requires the corner leg to be positioned beneath the standard leg, with one operative holding the Platform off the ground; the other operative fits the corner leg in position. **(Note; the Stand Off Kit, Dormer Kit and Rolling Window Bar may also be used in conjunction with the Corner Kit- the back Bolt and Wing Nut is removed, in each case, and the Corner Leg Pin is inserted from the inside out, with the 'R' Clip fixed into the pin inside the stalk of the accessory)**
- Extend the Standard Legs in length by two holes from the shortest position.
- Lift the platform up against the wall using the same Solar Platform technique, albeit that one operative needs to lift two legs.
- Roll the platform up the wall, allowing the Corner Leg to “swing” into position. Complete the Platform leveling procedure.
- Extend the Corner Leg to the ground with the foot as near to the wall as possible or beyond, secure with the Pin and 'R' Clip.
- Fit the adjustable Horizontal Brace



- Fit the Back Leg to the other Standard Leg.
- Complete the ladder and Guard-rail fitting procedure.
- Now adjust the height of the Platform, to one more suitable for working. **Note: It will be necessary to remove the horizontal brace and back leg prior to raising the height.** Once adjusted refit the back leg and horizontal brace.
- Maneuver the Platform into position, overhanging the corner of the building, and adjust the Corner Leg to the optimum position.

Safety Precautions

- Fit the corner leg to mirror the angle of the Standard Leg to form an “A” shape.
- **Always** fit the adjustable horizontal Brace
- **Always** tie off the Dec to the structure with a suitable anchor for the base material and make sure it is installed as per manufacturer’s instruction.
- It is important when handling the Easi-Dec products in hot weather, that the appropriate PPE is used for resistance against thermal heating of the material.
- **Always** if the Catwalk Staging is not present fit the Standoff Front Handrail and Toe Board to fully guard the Platform.

Positioning the Catwalk Staging



- After the Two Easi-Dec Platforms have been erected, lay the staging on the ground will help determine the position of the Decs. Make sure there is a minimum of 300mm overhang each side. The ladders will need to be repositioned to the inner ends of the platforms extending just above the level of the platform. Ensure they are tied off. Install the centre posts on the Catwalk.
- Two operatives will need to lift the catwalk into position. Tie one end with rope and stand the catwalk against the Easi-Dec's. The operative on this platform needs to clip on with a harness and hold the catwalk end. The second operative will clip on with a harness and pull the catwalk up into position. Double strap the staging on at both ends.
- Fit the inner and outer handrail sets to the staging as described in the assembly instructions along with the Toe Boards.

Safety Precautions

- **Always** ensure you are fully clipped in with harness before raising the staging.
- **Always** ensure a minimum of 300mm of the staging sits on each platform.

- **Always** strap the staging securely onto the platform
- **Always** use Pins and “R” clips to fix the posts in the staging sockets.
- Maximum distributed load = 600Kg evenly distributed.

Dismantling the Easi-Dec Platform & Roofline System

- When you wish to dismantle the Easi-Dec system reverse the sequence specified in the assembly instructions. Always adjust to the lowest height before dismantling. Allow the leg to slide through your hands when rolling the Dec down the wall so as to maintain balance whilst lowering the platform to the ground.

Positioning the End Support Frames

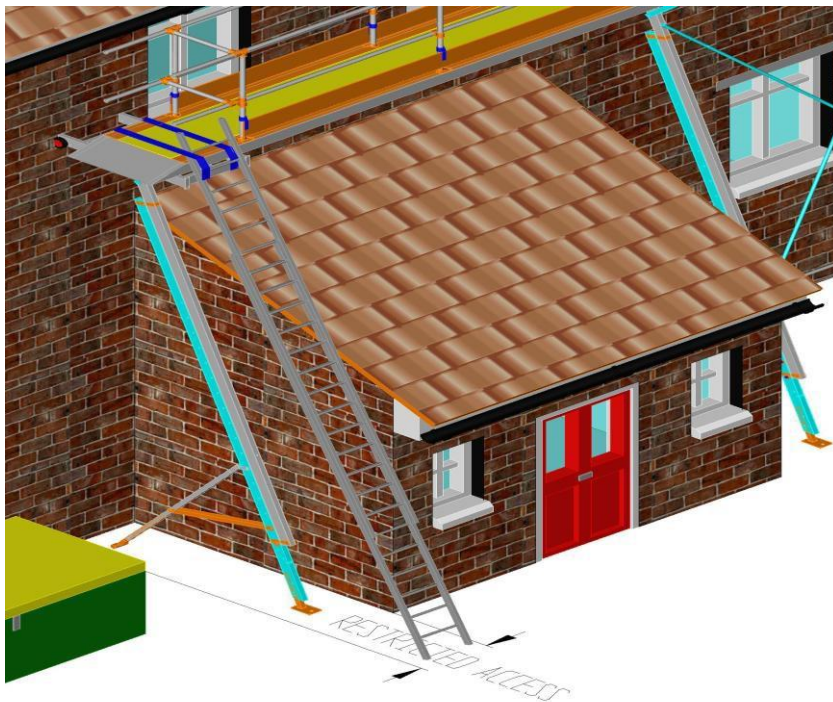

Erecting the End Support Frame

- When Lifting the End Support Frame, use bent knees and a straight back, up to waist height then, using your arms, to offer it to the wall, and roll it up into position.
- Adjust for height and level to match the Easi-Dec Platform.
- Fit the Back Leg.

- Top Fix the End Support Frame by drilling the wall, fitting a Ring Bolt, and tying the assembly to the structure.
- The Catwalk Staging may now be erected similarly to that using two 2 Metre Easi-Decs.
- Ensure both Ladders are fixed top and bottom and not more than 4 Meters apart.
- Install the centre posts into the Catwalk Staging.
- Position the Catwalk Staging carefully, as described in the assembly/erection procedure. Position it on the Easi-Dec Platform and the End Support Frame ensuring at least 300mm is on the Platform, and cover all three mullions of the End Support Frame.
- Replace the Guard-rail Set on the Easi-Dec Platform, folding the end section outward, and Strap the Catwalk Staging down to the Platform first.
- Use two Straps to secure the End Support Frame to the other end of the Catwalk Staging; one each side of the Single Leg.
- Fit the end Posts into their sockets and secure them with the Pins and “R” Clips.
- Carefully locate the inside and outside Mid Rails over the Posts and lower into position.
- Now locate the End Frame Mid and Top Rails over the end Posts.
- Next fit the Top Rails and tighten with the Allen Key provided. Draw the End Top Rail up under the side Top Rails and tighten also.
- Finally fit all Toe Boards and secure with the Clamps. Clip the loose Guard-rail of the Platform back to the Catwalk Staging Toe Board.

Safety Precautions

- **Always** fit the Back Leg.
- **Always** tie off the End support Frame to the structure with a suitable anchor for the base material and make sure it is installed correctly as per manufacturer’s instruction.
- **Always** take great care when raising / assembling the Catwalk Staging.
- **Always** ensure the Catwalk Staging sits completely over the End Support Frame.
- **Always** strap the Catwalk to the Easi-Dec Platform first.
- **Always** use two straps to secure the Catwalk Staging to the End Support Frame.
- **Always** use with an Easi-Dec Platform at one end.

- **Always** use the end Hand Rail, Mid Rail and Toe Board to close off the end of the Catwalk Staging.
- **Never** Use the End Support Frame in pairs, to support a Catwalk at each end.
- **Never** Use in gaps greater than 350mm without tying off.

Positioning the 2m Easi Dec Platform with Super Legs

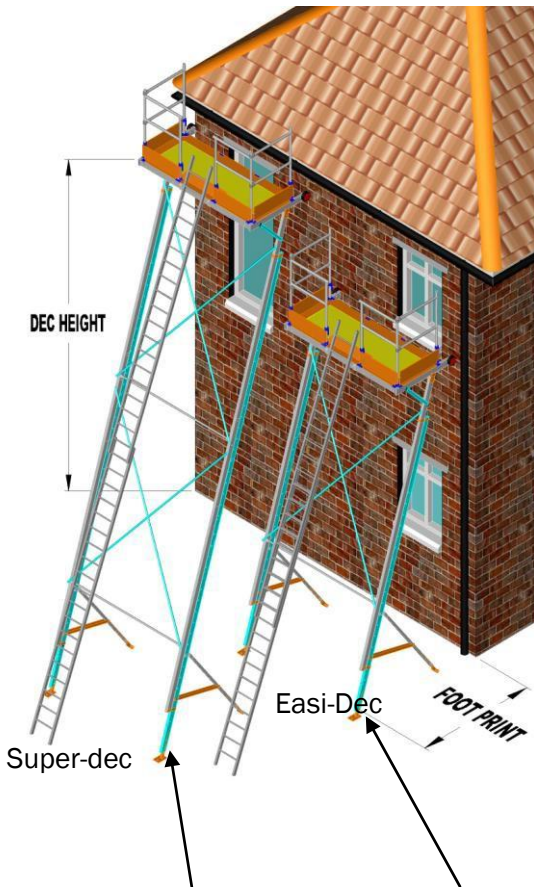

- **Table 1 & 2** – Shows the minimum and maximum heights of the Easi-Dec's with various Leg types. **REMEMBER:** Follow the assembly instructions when assembling the Dec's.
- **Table 3** – Shows the foot print of the Easi-Dec's set at maximum heights with standard wheels and with stand-off arms.

Table 1 - MAXIMUM

LEG TYPE	LEG LENGTH	ANGLE FACTOR	DEC HEIGHT (M)	DEC HEIGHT (ft)
14" (SHORT CLAW)	4.506m	0.95	4.360m	14' 3-1/2"
14" (STD CLAW)	4.806m	0.95	4.645m	15' 2-3/4"
16" (STD CLAW)	5.106m	0.95	4.930m	16' 2"
18" (STD CLAW)	5.706m	0.95	5.5m	18' 1/2"
SUPER LEG	7.156m	0.95	6.877m	22' 6-3/4"

Table 2 - MINIMUM

LEG TYPE	LEG LENGTH	ANGLE FACTOR	DEC HEIGHT (M)	DEC HEIGHT (ft)
14"	2.587m	0.95	2.537m	8' 4"
16"	2.887m	0.95	2.822m	9' 3"
18"	3.487m	0.95	3.392m	11' 1-1/2"
SUPER LEG	4.486m	0.95	4.340m	14' 2-3/4"

Table 3 - FOOTPRINT

FOOTPRINT PLATFORM HEIGHT	4.360m	4.645m	4.930m	5.5m	6.877m
STANDARD WHEELS	1.68m	1.85m	2.00m	2.18m	2.69m
WITH STAND-OFF ARMS	1.88m	2.05m	2.2m	2.38m	2.89m

Erecting the 2m Dec Platform with Super Legs

- Once assembled Lift the Super-Dec into position as described in the 2m Dec Erection procedure.
- Raise the height using the strap and pulley system. Refer to assembly Instructions.

Using Easi-Dec & Roofline System 2-45 of 57

- When the Leg heights are beyond the reach of operatives, a perch is used to stand on to gain extra height when attaching the locating pin. The second operative must hold the platform in place using the strap provided.
- Take care to control the descent of the Dec using the straps when dismantling.

Safety Precautions

- **Always** seek additional help, due to the extra weight of the Super-Dec assembly, especially when used in the Dormer position.
- **Always** use the Guard-rail and fit it at the lowest height.
- **Always** take care to control the descent of the Dec using the straps.
- To comply with the BS EN 12811 & EN13374 then the Dec's needs to be tied into the structure, however a risk assessment should to be undertaken in all instances to ascertain the correct procedure.

Remember: always tie the Dec's into the structure if used as edge protection.

- It is important when handling the Easi-Dec products in hot weather, that the appropriate PPE is used for resistance against thermal heating of the materials.
- **Never** Use a Super Leg with an End support Frame.

Positioning the 2m Window Dec

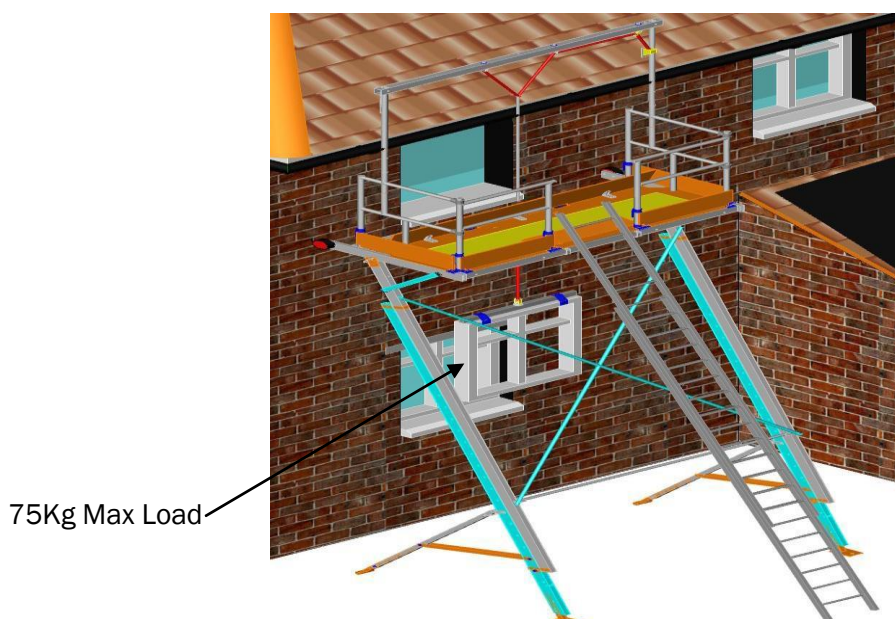

Erection Procedure for the 2m Window Dec

- Erect the Window Dec as described under “2 Metre Easi-Dec” to the desired height and position.
- Refer to the assembly instructions for Window Dec to erect the pulley system.
- The „Window” beam can now be lowered through the Hatch to a suitable height for attaching the window or solar panel.
- Ensure the load is fixed firmly to the beam to prevent the load from moving within the harness and centrally in order to lift “squarely” and not lop sided.
- Before attempting to lift the load, ensure the clutch lever is in the locked position. The clutch will then automatically hold the weight of the load allowing the operator to safely hoist the load to Platform level. There are two guide straps attached to the harness that allow a second person to guide the window from below as it is lifted. This person must stand outside the Dec legs, not below the load.
- When the load has been hoisted clear of Dec, the hatch should be closed and the load lowered onto the Platform in order to release it from the straps.
- **NOTE:** When lowering, take the strain on the rope whilst gently opening the clutch lever in order to release the brake. The speed of descent may be controlled with careful control of the clutch lever. Alternatively, the descent may be controlled by the operator using the rope.

NEVER allow the rope to slip through your hands, it will burn!

Safety Precautions

- **Always** check for Overhead power cables and obstructions.
- **Always** check all aspects of the Easi-Dec Platform before use if the equipment is left unattended for any period of time.
- **Always** access the site for suitability. Top fixing the Dec maybe required however a risk assessment should to be undertaken in all instances to ascertain the correct procedure.

Remember: always tie the Dec’s into the structure if used as edge protection.

- It is important when handling the Easi-Dec products in hot weather, that the appropriate PPE is used for resistance against thermal heating of the materials.
- **Never** use against green/fresh brickwork.
- **Never** use in high winds – maximum 17mph without tying.
- **Never** exceed the maximum distributed load of 300 Kg.

- **Never** exceed the 75 Kg on the Lifting Gantry.
- **Do not** man ride.

Positioning the Mono Dec and 6m Trimline System.

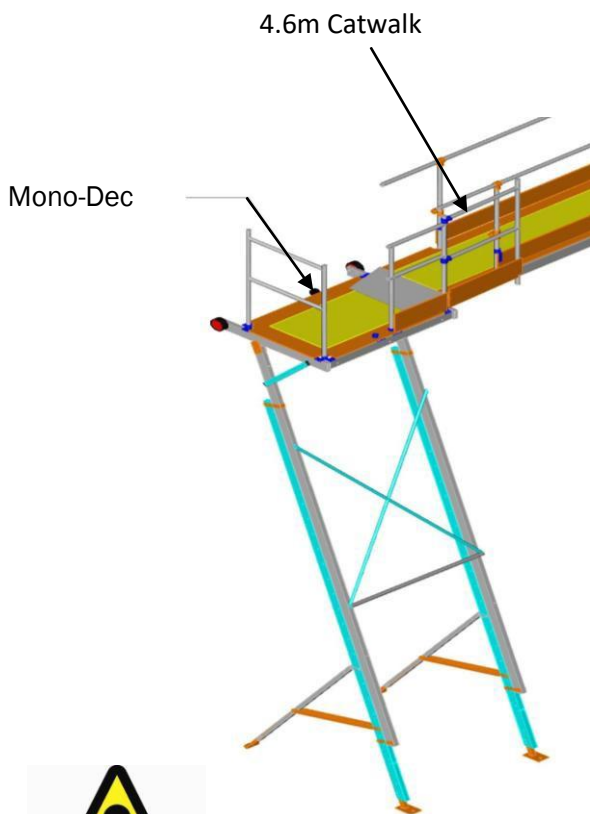

- Position the Mono-Dec in the same way as the Easi-Dec Platform described in „**The 2 metre Easi-Dec Platform**’ Erection/Dismantle procedure.
- When erecting Mono-Dec with Catwalk staging follow the same installation procedures described in Installation of Catwalk staging.

Safety precautions

- Follow the safety procedures described in the 2m Dec and Catwalk staging installation procedures.
- Always tie the Mono-Dec to the building with the Ring bolt supplied.



DANGER! The pullout strength of the ring type drilled in anchor tie supplied with all the Dec’s, is dependent on the strength value of the brickwork or building face to which it is attached. In some cases, stone facing, cavity walls, defective or unsound brickwork may not be suitable for this type of tie in such a case a fixing manufactures advice should be sought. If the base material differs from the aforementioned then an anchor fixing specialist needs to be consulted to establish the correct type of anchor. The anchor should be able to withstand a minimum pull out load of 0.3 KN in the horizontal direction.

Using the Easi-Dec Platform & Roofline System

Contents

How to use the system correctly.



Danger!

Do not use the Easi-Dec Platform & Roofline System if defects are identified during the checks described below or doubts exist over the integrity of the system. Defects can endanger life! Users of the system should be free from any disability that may affect them working at height in accordance with all relevant Health and Safety Regulations.

Always make the following checks before using the system!

Always carry out a check of the Easi-Dec Platform & Roofline System before use.

The check must include the following items:

- Check for signs of damage before use.
- Back legs must always be fitted – Top fixing or staking of the feet may be made in addition.
- Ensure the platform is level.
- Ensure that securing pins and „R' Clips must be correctly fitted and secure.
- Make sure the Ladder is at the correct angle and tied off using straps provided.
- Ensure the wall is structurally sound before erecting the Easi-Dec Platform against it.
- Check Plywood decking and toe boards are in sound condition before use.
- Make sure the Dec is tied to the structure with a suitable anchor for the base material and make sure it is installed correctly as per manufacturer's instruction.

Always Ensure!

Each inspection must be recorded in an inspection book!

You will find a sample page at the end of these operating instructions.

Selection of suitable personal protective equipment



Advice!

The selection of suitable personal protective equipment (PPE) can only take place based on a risk assessment, which has been carried out in advance. The risk assessment and the selection of the PPE must be documented in writing!

ADVICE

Personal protective equipment (lanyard etc.) is not included with the Easi-Dec Platform & Roofline System. Personal protective equipment formed no part of the tests carried out by Ceram. Please ask your supplier for help in selecting the personal protective equipment suitable for you. The manufacturer of the chosen PPE must affirm that it can be used in the horizontal configuration and over the edge of any potential drop.

The personal protective equipment selected for protection against a fall must consist of the following parts:

Make sure that the personal protective equipment is suitable as a full fall restrained system. Consult the manufacturer if necessary.

During use ensure all PPE is protected from exposure to thermal electrical and mechanical shock or chemical attack

An emergency plan is in place for the recovery of any person who may fall.

Final inspection before use

After you have connected, ensure:

- All fasteners and bolts are correctly tightened.
- Re- Check the equipment if left unattended for any period of time.

Maintenance, Inspection and Disposal

Contents

Information on the care and regular inspection of the Easi-Dec Platform & Roofline System, to be carried out by a competent person who is familiar with the product.

Re-Selling

Should the Easi-Dec Platform & Roofline System be re-sold or exported outside of the original country of destination, the re-seller shall provide the user with these instructions in the language of the country in which the product is to be used.

Cleaning

In most cases cleaning with clean water is adequate. You can use a water hose or high-pressure cleaner for this purpose. If you are unsure of the nature of any contamination contact the manufacturer for advice. After cleaning or when the system has become wet through use, the system must be allowed to air dry naturally and be kept away from direct heat before next use.

Maintenance

- Any damaged or corroded components and damaged bolts must be exchanged for original spare parts before using again.
- Check all Pin and „R’ clips are present and in good condition.
- Check all rivets and bolts are tight (Weekly intervals)
- Check Plywood Decking and Toe-boards are in sound condition.
- Lubricate the gate sockets on the Dec with Silicone oil.
- Always store cross-braces, pins & ‘R’ clips and Dec support struts properly.
- If in doubt contact Easi-Dec.
- An inspection service of your Easi-Dec equipment is available on request.

Regular Obligatory Inspection of the Easi-Dec & Roofline System

General

WARNING! The safety of users depends upon the continued efficiency and durability of their equipment. It is recognised that checks, inspections and examinations are a contributory factor in reducing risks. It is essential, therefore, that these inspections and examinations are carried out as recommended, and as required by National regulations.

Pre-use checks, inspections and examinations should only be carried out by persons competent to do so. A competent person is defined as a designated person who is knowledgeable of the current checking, inspection and examination requirements, recommendations and instructions issued by the manufacturer applicable to the relevant component, subsystem or system. This person should be capable of identifying defects, should be responsible for initiating the corrective action to be taken and should have the necessary skills and resources to do so.

Once in place at the worksite, the Easi-Dec Platform & Roofline System combination should be checked before each use (*Pre-use check* – see below) to ensure that the whole system functions correctly.

After every week of constant use, every six weeks of intermittent use and on each occasion of re-assembly, before they are used again, Easi-Dec Platform & Roofline System should be more closely inspected, e.g. for signs of damage, to ensure that it is safe for re-use. This inspection (i.e. *interim inspection*) should be recorded.

At least every 12 months there should be a *thorough examination* (i.e. a detailed inspection, more thorough than the interim inspection) This thorough examination should be recorded on the Inspection sheet attached.

Pre-use checks.

Before each use of this equipment, including after initial assembly, carry out a pre-use check to ensure that it is in an acceptable condition and that it operates correctly. This check should include at least the points below:

Make a final inspection of the assembled Easi-Dec Platform & Roofline System. Ensure that all the instructions for their assembly and location have been followed. Special attention should be paid to the following:

- (a) Back legs are fitted. Top fixing or staking of the feet may be made in addition.
- (b) All pins and „R’ clips must be correctly fitted and secure.

- (c) Ensure platform is level before use.
- (d) All safety gates and toe boards are fitted correctly.
- (e) Ladder at the correct angle and tie off using the straps provided.
- (f) Catwalk should be strapped with a minimum of 300mm overhang on each Dec.
- (G) Make sure the Dec is tied to the structure with a suitable anchor for the base material and make sure it is installed correctly as per manufacturer's instruction.

WARNING! Should any doubt arise about the safety of any part of the system, do not use it and remove it from service immediately.

Instructions for periodic examination

What to look for during, inspections and thorough examination

The lists below are not exclusive.

Inspection (Interim inspection)

An inspection should be carried out after every week of constant use, every six weeks of intermittent use and on each occasion of re-assembly, and recorded. In addition to the pre-use checks. Inspect for the following:

- (a) For signs of corrosion, wear, distortion or other defects on all parts including bolts and nuts and "R" Clips;
- (b) That the maximum Load warning notices are still intact and legible on the sides of the Easi-Decs. (Replacements notices are available from your Easi-Dec and Roofline System supplier.)
- (c) Unless stored securely out of use, re-assemble in accordance with section 2.5 of this document.
- (d) Should any doubt arise about the safety of any part of the system, do not use it, remove it from service immediately, and seek advice from your Easi-Dec supplier.

Thorough Examination (Detailed inspection)

A thorough examination should be carried out and recorded on the Inspection Record by a competent person, authorised by the manufacturers approved agent, at least every 12 months.

Ensure that Easi-Dec Platform & Roofline System is completely dismantled and inspect as follows:

All checks as per interim inspection.

In addition;

- a) That there is no wear or distortion of the holes through which the various bolts and pins are passed,
- b) That there is no deformation of any of the pins or bolts, or of their threads.
- c) That there is no damage to any components of the Easi-Dec Platform & Roofline System.

Should any doubt arise about the safety of any part of the system, do not use it, remove it from service immediately and seek advice from your Easi-Dec supplier.

Instructions for repair; following a fall or any other possibly damaging event.

If an operative suffers a fall from a height while using the Easi-Dec Platform, or if it becomes damaged in any way, the manufacturer should be contacted and arrangements made to return it to them for inspection and any necessary repair.

WARNING! Do not attempt to repair the Easi-Dec Platform & Roofline System unless written permission has been obtained from the manufacturer or authorised representative.

Records

It is strongly recommended that a record be kept for each Easi-Dec Platform. The record should contain headings for and spaces to allow entry of at least the details shown in the **appendix**:

Markings on the products and their meaning

Various markings can be found on Easi-Dec & Roofline System and are listed below.

2m Dec, Dormer Dec and Window-Dec Labels

Label 1 – Safety procedures before Accessing the Platform.



SAFETY PROCEDURES *Always wear your HardHat!*

BEFORE ACCESSING THE EASI-DEC PLATFORM CHECK:

1. **Back Legs** must always be fitted. Top fixing or staking of the feet may be made in addition.
2. All **Pins** and **'R'** clips must be correctly fitted and secure.
3. Ensure platform is **level** before use.
4. Always use the **safety gates** and **toe boards**.
5. Erect your ladder at the correct angle and **tie off** using the straps provided.
6. **Do not** use against 'green' (new) brickwork.
7. **Do not** use in High winds.
8. **Do not** exceed the maximum distributed load of 300 Kgs.
9. Be aware of overhead power cables.
10. **If in doubt refer to the instructions or your supervisor.**
11. If the equipment is left unattended checks 1-5 must be repeated.
12. **Do not** use a ladder or step ladder to gain extra height from the platform.

MAINTENANCE

1. Check all Pins and 'R' clips are present and in good condition.
2. Check all rivets and bolts are tight (weekly intervals).
3. Check Plywood Decking and Toeboards are in sound condition.
4. Lubricate the gate sockets on the Dec with WD 40 (weekly).
5. Always store the cross-braces, pins & 'R' clips, and Dec support struts properly.
6. If in doubt contact the Easi-Dec office for advice.
7. A free inspection service of your equipment is available on request.

Look after your Easi-Dec and it will look after you! For technical advice contact **EASI-DEC ACCESS SYSTEMS LTD** on **01767 691812**

Label 2 – Warning Label Additional Height



Label 3 – Max Distributed Load Label



Label 4 – Dormer Leg position only.



Label 5 – Normal use Leg position

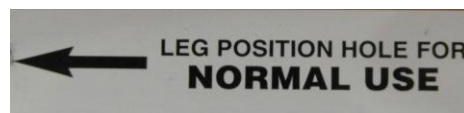

Label 6 – Supplier Label - Easi-Dec



Label 7 – Green Spot indicates



Right hand Leg fixing point

Label 8 – Red Spot indicates Left hand Leg fixing point



Label 9 – Window Dec safe Lifting Load.



Label 10 – Window Dec clutch release warning!



Label 11 – Double Dormer pitch indicator.



Label 12 – Dormer Dec strut label.



Platform Leg, Labels.

Label 1 – Safety procedures before Accessing the Platform.



Label 2 – Fixing point position.



Label 3 – Pin and clip must be secured x 2



Label 4 – Corner Leg indicator



Label 5 – Cross brace stowed position.



Catwalk End Support

Label 1 – Catwalk End support frame instructions



TrimLine

Label 1 – Fixing point position.



Label 2 – Warning Label Additional Height x 2



Stand-Off Kit

Label 1 – Front handrail indicator.



Label 2 – Stand-off arms indicator.

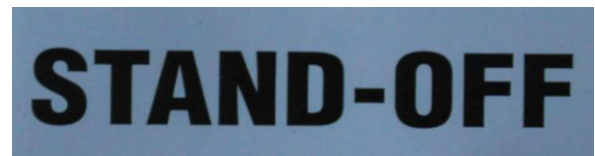

Disposal

The Easi-Dec Platform & Roofline System consists predominantly of Non Ferrous metals and plywood.

- The system can, therefore, be disposed of in a scrap-metal facility

ISSUE No.	AMMENDMENTS MADE	DATE MODIFIED
1	First Issue	07/03/12
2	Second Issue	20/12/16



Inspection and Result of the Regular Obligatory Inspection of Easi-Dec Platform & Roofline System

Date	Inspector Name / Qualification	Inspection Result	Subsequent Inspection in the Case of Deficiency (Date)	Result of the Subsequent Inspection	Signature of the Inspector	Next Inspection Due